

I . Introduction.....	
1. Checks upon Delivery	2
2. Nameplate Description of HY Series Inverter	2
II . Safety Precautions.....	4
1. Before the Power-up.....	4
2. During the Power-up	6
3. During the Operation.....	6
III. Standards and Specifications.....	7
1. Particular Specifications	7
2. General Specifications.....	8
IV. Storage and Installation.....	
1. Storage	8
2. Installation Site and Environment	9
3. Installation and Direction	9
V . Wiring.....	10
1. Main Circuit Wiring Schematic Diagram	10
2. Description of Terminal Block.....	11
3. Basic Connection Diagram	13
4. Precautions on Wiring	14
VI. Instruction of the Digital Operator	
1. Description of the Digital Operator.....	
2. Description of Indicator Lamp Status.....	16
3. Description of Operation Examples	18
VII. Commissioning	
1. Checks before the Commissioning.....	19
2. Commissioning Methods	19
VIII. Function List	
IX. Descriptions of Functions	
X. Care & Maintenance, Fault Information and Troubleshooting	
1. Precautions about Inspection and Maintenance	70
2. Periodical Inspection and Maintenance items.....	错误！未定义书签。
3. Fault Indication and Troubleshooting.....	错误！未定义书签。
4. Faults and Analysis.....	错误！未定义书签。
XI. Selection of Peripheral Devices and Disposition.....	错误！未定义书签。

1. Options..... 错误！未定义书签。
2. Disposition..... 错误！未定义书签。

XII. User Preferences Table.....78

Note: Due to product updates, the manual is subject to change without notice.

I . Introduction

Thank you for purchasing and using the general-purpose inverter of HY series of multi-functions and high performance.

Please read carefully the operation manual before putting the inverter to use so as to correctly install and operate the inverter, give full play to its functions and ensure the safety. Please keep the operation manual handy for future reference, maintenance, inspection and repair.

Due to the inverter of a kind of electrical and electronic product it must be installed, tested and adjusted with parameters by specialized engineering persons of motors.

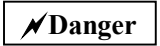
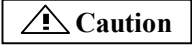
The marks of  **Danger**  **Caution** and other symbols in the manual remind you of the safety and prevention cautions during the handling, installation, running and inspection. Please follow these instructions to make sure the safe use of the inverter. In case of any doubt please contact our local agent for consultation. Our professional persons are willing and ready to serve you.

The manual is subject to change without notice.

 **Danger** indicates wrong use may kill or injure people.

 **Caution** indicates wrong use may damage the inverter or mechanical system.

-  **Danger**
- Be sure to turn off the input power supply before wiring.
 - Do not touch any internal electrical circuit or component when the charging lamp is still on after the AC power supply is disconnected, which means the inverter still has high voltage inside and it is very dangerous.
 - Do not check components and signals on the circuit boards during the operation.
 - Do not disassemble or modify any internal connecting cord, wiring or component of the inverter by yourself.
 - Be sure to make correct ground connection of the earth terminal of the inverter.
 - Never remodel it or exchange control boards and components by yourself. It may expose you to an electrical shock or explosion, etc.

-  **Caution**
- Do not make any voltage-withstanding test with any component inside the inverter. These semi-conductor parts are subject to the damage of high voltage.
 - Never connect the AC main circuit power supply to the output terminals U.V W of the inverter.
 - The main electric circuit boards of CMOS and IC of the inverter are subject to the effect and damage of static electricity. Don't touch the main circuit boards.

- Installation, testing and maintenance must be performed by qualified professional personnel.
- The inverter should be discarded as industrial waste. It is forbidden to burn it.

1. Checks upon Delivery

The inverter has been strictly and well packed before ex-work. In consideration of various factors during the transportation special attention should be paid to the following points before the assembly and installation. If there is anything abnormal please notify the dealer or the relevant people of our company.

- Check if the inverter has got any damage or deformation during the transportation and handling.
- Check if there is one piece of HY series inverter and one copy of the instruction manual available when unpacking it.
- Check the information on the nameplate to see if the specifications meet your order (Operating voltage and KVA value).
- Check if there is something wrong with the inner parts, wiring and circuit board.
- Check if each terminal is tightly locked and if there is any foreign article inside the inverter.
- Check if the operator buttons are all right.
- Check if the optional components you ordered are contained.

2. Nameplate Description of HY Series Inverter

MODEL:	HY07D543B
INPUT:	3PH380V50Hz
OUTPUT:	3PH380V17.5A7.5KW
Freq-Range:	0.1~400Hz
HY ELECTRONICS	

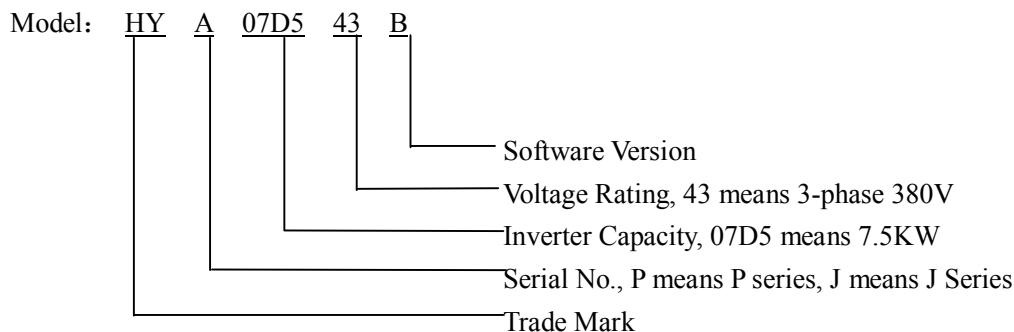

II. Safety Precautions

1. Before the Power-up

Caution

- Check to be sure that the voltage of the main circuit AC power supply matches the input voltage of the inverter.
- The symbol, , represents ground terminals. Be sure to make correct ground connection of the earth terminals of the motor and the inverter for safety.
- No contactor should be installed between the power supply and the inverter to be used for starting or stopping of the inverter. Otherwise it will affect the service life of the inverter.

Danger

- R.S.T terminals are power input terminals, never mixed with U.V.W terminals. Be sure that the wiring of the main circuit is correct. Otherwise it will cause damages of the inverter when the power is applied to it.

⚠ Caution

- Do not carry the front cover of the inverter directly when handling. It should be handled with the base to prevent the fall-off of the front cover and avoid the dropping of the inverter, which may possibly cause the injuries to people and the damages to the inverter.
- Mount the inverter on a metal or other noncombustible material to avoid the risk of fire.
- Install the inverter in a safe location, avoiding high temperature, direct sunlight, humid air or water.
- Keep the inverter from the reach of children or persons not concerned.
- The inverter can only be used at the places accredited by our company. Any unauthorized working environment may have the risks of fire, gas explosion, electric shock and other incidents.
- Install a heat sink or other cooling device when installing more than one inverter in the same enclosure so that the temperature inside the enclosure be kept below 40°C to avoid overheat or the risk of fire.
- Be sure to turn off the power supply before disassembling or assembling the operation keypanel and fixing the front cover to avoid bad contact causing faults or non-display of the operator.
- Do not install the inverter in a space with explosive gas to avoid the risk of explosion.
- If the inverter is used at or above 1000m above seal level, the cooling efficiency will be worse, so please run it by de-rating.
- Do not install any contactor and other components of capacitor or varistor on the output side of the inverter. Otherwise it will cause malfunctions and damages of components of the inverter.
- Do not install any switch component like air circuit breaker or contactor at the output of the inverter. If any of such components must be installed because of the requirements of process and others, it must be ensured that the inverter has no output when the switch acts. In addition, it is forbidden to install any capacitor for improvement of power factor or any varistor against thunder at the output. Otherwise it will cause malfunctions, tripping protection and damages of components of the inverter. Please remove them as shown in the below diagram.
- It will affect the service life of the inverter if a contact is connected to the front end of input of the inverter to control its starts and stops. Generally it is required to control it through FOR or REV terminals. Special attention should be paid to its use in the case of frequent starts and stops.
- Please use an independent power supply for the inverter. Do avoid using the common power supply with an electrical welder and other equipment with strong disturbance. Otherwise it will cause the protection or even damage of the inverter.

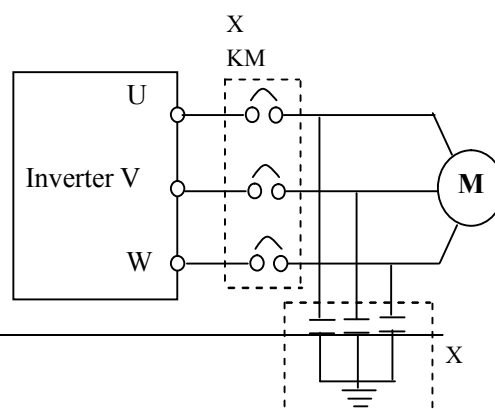



2. During the Power-up

 **Danger**

- Do not plug the connectors of the inverter during the power up to avoid any surge into the main control board due to plugging, which might cause the damage of the inverter.
- Always have the protective cover in place before the power up to avoid electrical shock injury.

3. During the Operation

 **Danger**

- Never connect or disconnect the motor set while the inverter is in running. Otherwise it will cause over-current trip and even burn up the main circuit of the inverter.
- Never remove the front cover of the inverter while the inverter is powered up to avoid any injury of electric shock.
- Do not come close to the machine when the fault restart function is used to avoid anything unexpected. The motor may automatically restart after its stop.
- The function of STOP Switch is only valid after setting, which is different with the use of emergent stop switch. Please pay attention to it when using it.

▲ Caution

- Do not touch the heat sink, braking resistor, or other heat elements to avoid being scald.
- Be sure that the motor and machine is within the applicable speed ranges before starting operation because the inverter is quite easy to run from lower speed to higher speed.
- Do not check the signals on circuit boards while the inverter is running to avoid danger.
- Be careful when changing the inverter settings. The inverter has been adjusted and set before ex-work. Do not adjust it wantonly. Please make proper adjustments according to the required functions.
- Do consider the vibration, noise and the speed limit of the motor bearings and the mechanical devices when the inverter is running at or above the frequency of 50Hz.



III. Standards and Specifications

1. Particular Specifications

Type	Input Voltage	Power (KW)	Inverter Capacity (KVA)	Output Current (A)	Suitable Motor (KW)
HY00D423B	Single & Three Phase 220V 50Hz	0.4	1.0	2.5	0.4
HY0D7523B	Single & Three Phase 220V 50Hz	0.75	2.0	5.0	0.75
HY01D523B	Single & Three Phase 220V 50Hz	1.5	2.8	7.0	1.5
HY02D223B	Single & Three Phase 220V 50Hz	2.2	4.4	11	2.2
HY0D7543B	3 Φ 380V 50Hz	0.75	2.2	2.7	0.75
HY01D543B	3 Φ 380V 50Hz	1.5	3.2	4.0	1.5
HY02D243B	3 Φ 380V 50Hz	2.2	4.0	5.0	2.2
HY03D743B	3 Φ 380V 50Hz	3.7	6.8	8.5	3.7
HY05D543B	3 Φ 380V 50Hz	5.5	10	12.5	5.5
HY07D543B	3 Φ 380V 50Hz	7.5	14	17.5	7.5
HY001143B	3 Φ 380V 50Hz	11	19	24	11
HY001543B	3 Φ 380V 50Hz	15	26	33	15
HY18D543B	3 Φ 380V 50Hz	18.5	32	40	18.5
HY002243B	3 Φ 380V 50Hz	22	37	47	22
HY003043B	3 Φ 380V 50Hz	30	52	65	30
HY003743B	3 Φ 380V 50Hz	37	64	80	37
HY004543B	3 Φ 380V 50Hz	45	72	91	45
HY005543B	3 Φ 380V 50Hz	55	84	110	55

HY007543B	3 Φ 380V 50Hz	75	116	152	75
HY009043B	3 Φ 380V 50Hz	90	134	176	90
HY011043B	3 Φ 380V 50Hz	110	160	210	110
HY013243B	3 Φ 380V 50Hz	132	193	253	132
HY016043B	3 Φ 380V 50Hz	160	230	304	160
HY018543B	3 Φ 380V 50Hz	185	260	340	185
HY020043B	3 Φ 380V 50Hz	200	290	380	200
HY022043B	3 Φ 380V 50Hz	220	325	426	220
HY025043B	3 Φ 380V 50Hz	250	481	480	250
HY028043B	3 Φ 380V 50Hz	280	427	560	280
HY030043B	3 Φ 380V 50Hz	300	450	580	300
HY031543B	3 Φ 380V 50Hz	315	460	605	315

2. General Specifications

Inverter Series	HY-A	
Control Mode	SPWM	
Input Power	330~440Vfor 380V power; 170~240for 220V power	
5-Digits Display & Status Indicator Lamp	Displaying frequency, current, revolution, voltage, counter, temperature, forward or reserve running, and fault, etc.	
Communication Control	RS-485	
Operation Temperature	-10~40℃	
Humidity	0-95% Relative Humidity (without dew)	
Vibration	Below 0.5G	
Frequency Control	Range	0.10~400.00Hz
	Accuracy	Digital: 0.01% (-10~40℃), Analog: 0.1% (25±10℃)
	Setting Resolution	Digital: 0.01Hz, Analog: 1‰ of Max. Operating Frequency
	Output Resolution	0.01Hz
	Operator Setting Method	Press directly    to set.
	Analog Setting Method	External Voltage 0-5V, 0-10V, 4-20mA, 0-20mA.
	Other Functions	Frequency lower limit, starting frequency, stopping frequency, three skip frequencies can be respectively set.
Ramp Control	Ramp Control	Selectable 4-speed steps ramp-up and -down time (0.1-6500s).
	V/F Curve	Set V/F curve at will

	Torque Control	Torque increase is settable by max. 10.0%. The starting torque can reach 150% at 1.0Hz.
	Multi-Inputs	6 multi-function input terminals for 8-speed steps control, program operation, switching of 4-speed Ramp, UP/DOWN function, counter, external emergency stop and other functions.
	Multi-Outputs	5 multi-function output terminals for displaying of running, zero speed, counter, external abnormality, program operation and other information and warnings.
	Other Functions	AVR (auto voltage regulation), Deceleration stop or free-stop, DC brake, auto reset and restart, frequency track, PLC control, traverse function, drawing control, auto energy-savings, carrier adjustable by max. 16KHz, etc.
Protection Functions	Overload Protection	Electronic relay protection motor Drive (for constant torque 150%/1 min. for the kinds of fan 120%/1min.)
	FUSE Protection	FUSE broken, Motor stops.
	Over-voltage	DC Voltage >400V for 220V class DC Voltage >800V for 380V class
	Low Voltage	DC Voltage <200V for 220V class DC Voltage <400V for 380V class
	Instant Stop and Restart	Restarted by frequency track after instantaneous stop.
	Stall Prevention	Anti-stall during Acc/Dec run
	Output End Shorts	Electronic circuit protecting
	Other Functions	Fin over-heat protection, restriction of reverse running, direct start after power on, fault reset, parameter lock PID, one-drive-more, etc.

IV. Storage and Installation

1. Storage

The inverter must be kept in its original package box before installation. Pay attention to the followings when keeping it in storage if the inverter is not used for the time being:

- It must be stored in a dry place without rubbish or dust.
- The suitable temperature for storage is between -20°C and +65°C.
- The relative humidity required is 0-95% without condensation.
- There is no corrosive gas or liquid in the storage ambience.
- It's better to lay the inverter on a rack and keep it in a proper package.
- It is better not to store the inverter for long time. Long time storage of the inverter will lead to the deterioration of electrolytic capacity. If it needs to be stored for a long time make sure to power it up one time within a year and the power-up time should be at least above five hours. When powered up the voltage must be increased slowly with a voltage regulator to the rated

voltage value.

2. Installation Site and Environment

The inverter should be installed at the following location:

- Ambient temperature -5°C to 40°C with good ventilation.
- No water drop and low moisture.
- Free from direct sunshine, high temperature and heavy dust fall.
- Free from corrosive gas or liquid.
- Less dust, oil gas and metallic particles
- Free from vibration and easy for service and inspection.
- Free from the interference of electromagnetic noise.

Attention: The ambient conditions of the inverter will affect its service life.

3. Installation and Direction

- There must be enough space left around the inverter for easy maintenance and cooling. See Diagram .
- The inverter must be installed vertically with the smooth ventilation for effective cooling.
- If there is any instability when installing the inverter, please put a flat board under the inverter bottom base and install it again. If the inverter is installed on a loose surface, stress may cause damage of parts in the main circuit so as to damage the inverter.
- The inverter should be installed on non-combustible materials, such as iron plate.
- If several inverters are installed, upper and lower, together in one cabinet, please add heat dissipation plates and leave enough space between the inverters. See Diagram.

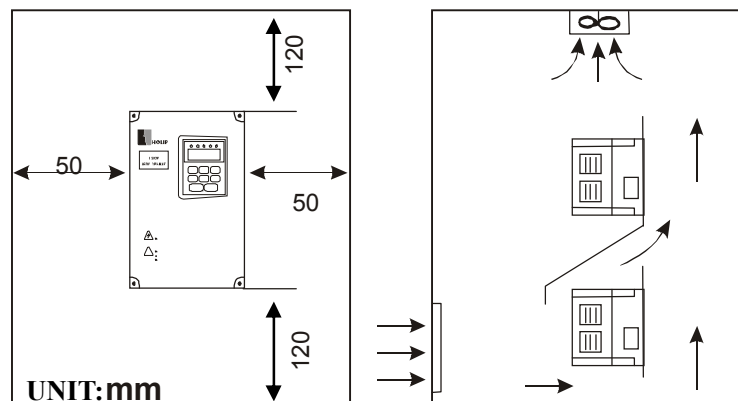

V. Wiring

1. Main Circuit Wiring Schematic Diagram(图标自己加)

Power supply:

- Verify that the inverter's rated voltage coincides with AC power supply voltage to avoid a damage of the inverter.

HY001143B~HY003043B
 HY05D523B~HY07D523B

R	S	T	E	P	N	U	V	W	
⊕	⊕	⊕	⊕	⊕	⊕	⊕	⊕	⊕	

HY003743B~HY016043B
 HY18D523B~HY002223B

R	S	T	E	P	P1	N	U	V	W
⊕	⊕	⊕	⊕	⊕	⊕	⊕	⊕	⊕	⊕



(2) Arrangement of Control Circuit Terminals

UPF	DRV	DCM	SPL	SPM	SPH	RST	REV	FOR	FOR			
	FA	FC	FB	DRV	+10	VI	AI	ACM	AM	RS-	RS+	

3) Function Description of Main circuit Terminals

Symbol	Function Description
R.S.T	Input terminal of AC line power. (220V class, for both single/three phase, single phase connected to any two phases)
U.V.W	Output terminal of the inverter
P.Pr	Connector for braking resistor.
P ₁ P	Connector for DC reactor (When using a DC reactor the jumper shall be removed. A05D543B and A07D543B internally jumped)
P、N	Connecting terminal of external braking bank.
E	Ground terminal: the third method of grounding for 220V and special grounding for 380 V of Electrical Engineering Regulations.

4) Function Description of Control Circuit Terminals

Symbol	Function Description	Factory setting
FOR	Multi-Input 1	Forward run
REV	Multi-Input 2	Reverse run
RST	Multi-Input 3	Reset
SPH	Multi-Input 4	High speed
SPM	Multi-Input 5	Middle Speed
SPL	Multi-Input 6	Low Speed
DCM	Common Terminal of Digital and Control Signals, +12v Power, (EV、IPV、 P24) Ground	
EV (IPV)	+12V Power Supply	Max. output current 200mA
P24	+12V Power Supply	Max. output current 200mA
+10	Power Supply for Speed Setting	+10V

VI	Analog Voltage Frequency Reference Input	0~+10V corresponding to the highest operating frequency
AI	Analog Current Frequency Reference Input	4~20mA corresponding to the highest operating frequency
ACM	Common Terminal of Analog and Control Signals	
DRV	Multi-Output 1 (Optical couple output)	DC24V/100mA
UPF	Multi-Output 2 (Optical couple output)	
FA (EFA)、 FB (EFB)、 FC (EFC)	Multi-Output 3 (N/O or N/C)	3A/250VAC
KA (EKA)、 KB (EKB)	Multi-Output 4 (N/O)	3A/250VAC
AM	Output terminals of digital frequency	0~10V
RS+ RS-	RS485 Communication port	

3. Basic Connection Diagram (图表请自行修改)

The wiring of the inverter is divided into two parts, main circuit terminal connections and control circuit terminal connections. The user can see the main circuit terminals, and the control circuit terminals after removing the cover of enclosure. The terminals must be connected correctly as the following wiring circuit diagrams.

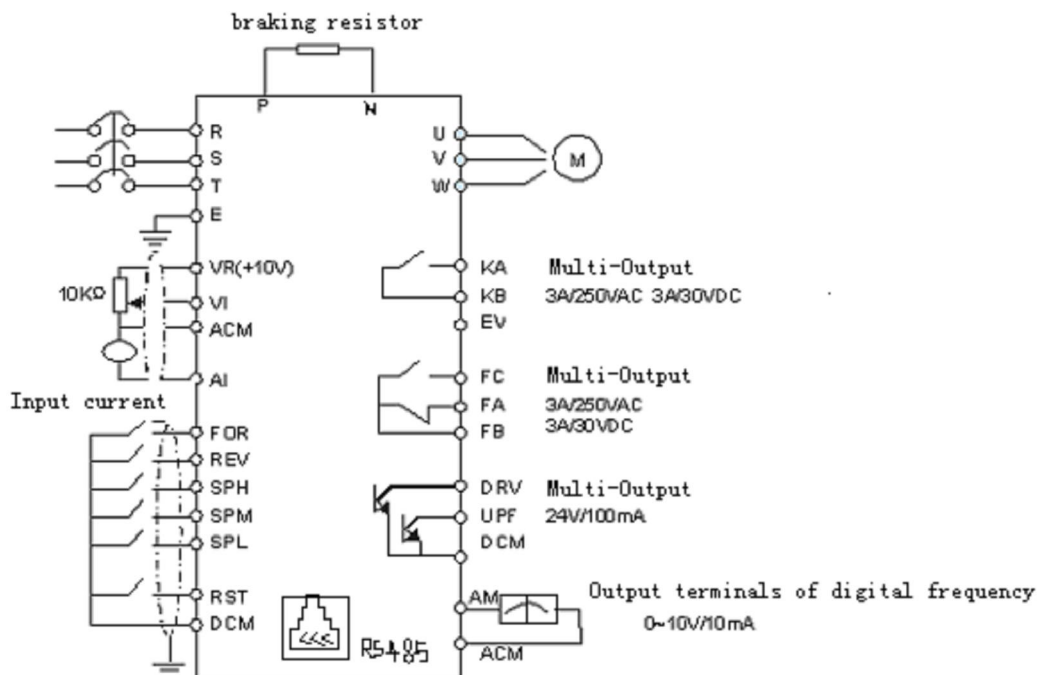

4. Precautions on Wiring

1) For the main circuit wiring:

- While wiring the sizes and specifications of wires should be selected and the wiring should be executed according to the electrical engineering regulations to ensure the safety.
- It is better to use shielded wire or wire and conduit for power cord and ground the shielded layer or two ends of wire conduit.
- Be sure to install a Non Fuse Breaker (NFB) between the power supply and the input terminals (R.S.T). (If using ground fault circuit interrupter, please choose one corresponding to high frequency)
- Never connect AC power to the output terminal (U.V.W) of the inverter.
- Output wires mustn't be in touch of the metal part of the inverter enclosure, or it will result in earth short-circuit.
- Phase-shifting capacitors, LC, RC noise filters, etc, can never be connected to the output terminals of the inverter.
- The main circuit wire must be enough far away from other control equipments.
- When the wiring between the inverter and the motor exceeds 15 meters for 220V class or 30 meters for 380V class, much higher dV/dT will be produced inside the coil of the motor, which will cause the destruction to the interlay or insulation of the motor. Please use a dedicated AC motor for the inverter or add a reactor at the inverter.
- Please lower the carrier frequency when there is a longer distance between the inverter and the motor. Because the higher the carrier frequency is the bigger the leakage current of high-order harmonics in the cables will be. The leakage current will have unfavorable effect on the inverter and other equipment.

2) For control circuit wiring (signal line)

- The signal line should be separately laid in a different conduit with the main circuit wire to avoid any possible interference.
- Please use the shielded cable with the size of 0.5-2mm² for signal lines.
- Use the control terminals on the control panel correctly according to your needs.

3) Grounding

- Grounding terminal E. Be sure to make correct grounding
220V class: The third grounding method (Grounding resistance should be 100 Ω or lower.)
380V class: The special third grounding method (Grounding resistance should be 10 Ω or lower.)
- Choose grounding wires according to the basic length and size of the technical requirements of the electric equipment.
- Do avoid sharing grounding wire with other large power equipment such as electric welder, power machine, etc. The grounding wire should be kept away from the power supply wires for large power equipment.

- The grounding method for several inverters together should be done as the first and second diagrams below. Avoid the third loop.
- The grounding wire must be as shorter as possible.

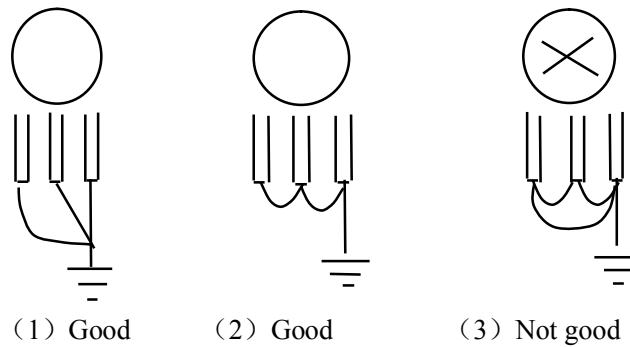

VI. Instruction of the Digital Operator

1. Description of the Digital Operator (图标自行修改)

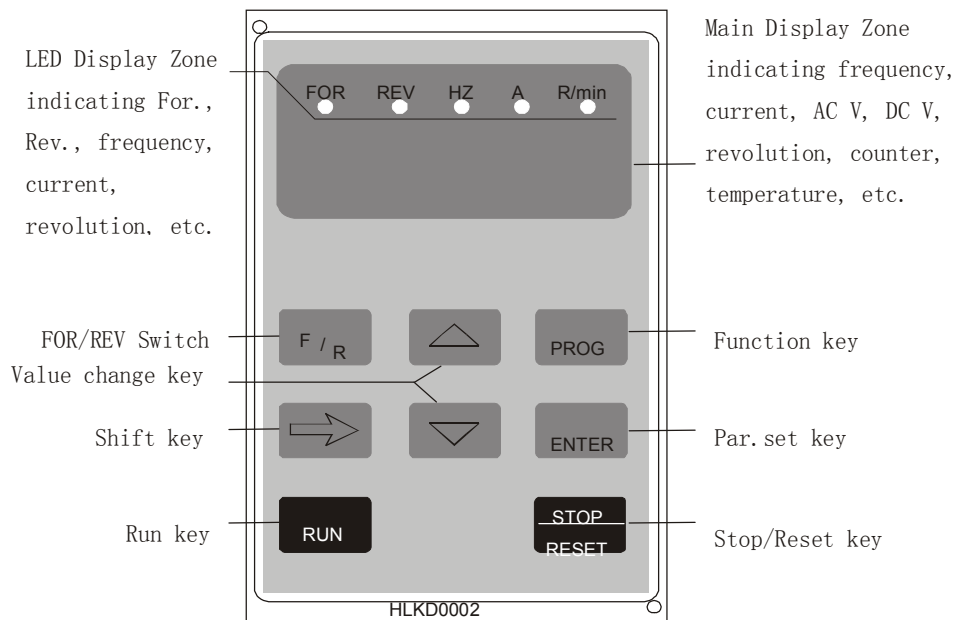

2. Description of Indicator Lamp Status

1) Description of Indicator Lamp Status

Indicator lamp	Status	Description
FOR	on	The motor is in forward rotation.
REV	on	The motor is in reverse rotation.
HZ	on	Displaying set frequency or output frequency.
A	on	Displaying output current.
ROTT	on	Displaying rated motor revolution
A ROTT	on	Displaying AC or DC voltage.
HZ ROTT	on	Displaying counting value.
HZ A ROTT	on	Displaying internal temperature of the inverter.

2) Description of Display Items

Display	Indic. lamp	on	Meaning
750.00	HZ A R/min X o o		Present output frequency is 50.00HZ
F50.00	HZ A R/min X o o		Present set frequency is 50.00HZ
A003.0	HZ A R/min o X o		Present output current is 3.0A
01440	HZ A R/min o o X		Present output revolution is 1440r/min
510.1	HZ A R/min o X X		Present DC voltage is 510.1V
380.0	HZ A R/min o X X		Present AC voltage is 380.0V
35.0	HZ A R/min X X X		Present inverter's temperature is 35.0°C
00105	HZ A R/min X o X		Present counter's value is 105
50.0	HZ A R/min o o o		Present target value of PID is 50.0%
48.0	HZ A R/min o o o		Present feedback value of PID is 48.0%
00012	HZ A R/min X X o		Present time of power-on is 12 hours
00108	HZ A R/min o X X		Total run time of inverter is 108 hours

3. Description of Operation Examples

Procedures	Display	Indicator Lamp	Explanation
Power up, Operation of	Dsp2.0 flash → Vr2.00	FOR HZ o X	Self detect when power-up, display version no. (Flashing) and finally set

power ↓	→ 000.00			frequency.
PROG ↓	PD000	FOR HZ ϕ ○		Enter programming Display the function of PD000
ENTER	000.00	FOR HZ ϕ ○		Display the contents of PD000
▲ ↓ ← ENTER ↓ PROG	50.00 END → 50.00 PD001 050.00	FOR HZ ϕ ○ FOR HZ ϕ ○		Change the content of PD000 Confirm changed value. Display END 50.00 PD001 Back from programming
↓ RUN	50.00	FOR HZ ○ ○		Display running and operating frequency
↓ ← DISP	50.00 0.00 → 50.00	FOR HZ ○ ○		Monitor screen switching, display output current
↓ PROG	005.0	FOR HZ ○ ○		Monitor screen switching, display output current
↓ ← DISP	01440	FOR A ○ ○		Monitor screen switching, display revolution
↓ PROG	50.00	FOR ROTT ○ ○		Switch back to main screen, display set frequency
↓ F/R	50.00	FOR HZ ○ ○		Switch of For.Rev. rotation, display the status of Rev rotation
↓ ▲	050.0	FOR HZ ○ ○		Switch to adjustable frequency
↓ ← ▲	050.00	FOR HZ ○ ○		Adjust set frequency, i.e. the value of PD000
↓ ENTER	030.00	FOR HZ ○ ○		Confirm changed value, write to PD000 as value
↓ STOP	50.00	FOR HZ ϕ ○		Stop

Note:

- ① ϕ means flashing. ○ means bright.
- ② For monitoring AC, DC, T and other items they can be only switched and displayed after the parameter setting.
- ③ When it is powered up again after a power breakdown the inverter will display the screen previous to the power breakdown after its self detection.

VII. Commissioning

1. Important Checks before the Commissioning

- If there is any wrong connected wires? Pay special attention to the terminal of U.V.W; Make sure the power supply wires are connected to R.S.T, not U.V.W.
- If there is any metal powder or wires left on the base plate of the inverter or the terminal block, which may cause short circuit.
- If screws are tightly locked and if the connecting parts are loose.
- If there is any short circuit or earth fault at outputs.

2. Commissioning Methods

The procedure of the operator is factory set up for the control mode of HY series. The commissioning can be carried out through the digital operator. Generally, the commissioning can be conducted at 5.00 Hz.

Procedures	Display	Indicator Lamp	Explanation
Power up ↓	dsp1.1→Vr2.0 ∨ 000.0 ∧	FOR Hz ϕ ○	Self detect when power up, display version no. and finally set frequency
△	000.00	FOR Hz ϕ ○	Switch to adjustable frequency on the panel
↓ ←△	050.00	FOR Hz ϕ ○	Change set frequency, i.e. the value of PD003
↓ ENTER	50.00	FOR Hz ϕ ○	Confirm changed value
↓ RUN	50.00	FOR Hz ○ ○	Run at 50Hz
↓ STOP	50.00	FOR Hz ϕ ○	Stop

Note: ○ means indicator lamps is on; ϕ means indicator lamps flash;

Category	Code	Function	Set Range & Function Explanation	Factory Setting
Basic Parameters	PD000	Parameter Lock	0: Invalid 1: Valid	0
	PD001	Source of Run Commands	0: Operator 1: External terminal 2: Communication port	0
	PD002	Source of Operating Frequency	0: Operator 1: External terminal 2: Communication port	0
	PD003	Main Frequency	0.00~400.00 Hz	0.00
	PD004	Base Frequency	0.01~400.00 Hz	50.00
	PD005	Max Operating Frequency	50.00~400.00 Hz	50.00
	PD006	Intermediate Frequency	0.01~400.00 Hz	2.50/3.0
	PD007	Min. Frequency	0.01~20.00 Hz	0.50
	PD008	Max. Voltage	0.1V—*	220/380
	PD009	Intermediate Voltage	0.1V—*	*
	PD010	Min. Voltage	0.1~50.0V	*
	PD011	Frequency Lower Limit	0.00~400.00 Hz	0.00
	PD012	Reserved		
	PD013	Parameter Reset	00~10 08: Restore the factory setting. No other function.	00
	PD014	Accel. Time 1	0.1~6500.0S	*
	PD015	Decel. Time 1	0.1~6500.0S	*
	PD016	Accel. Time 2	0.1~6500.0S	*
	PD017	Decel. Time 2	0.1~6500.0S	*
	PD018	Accel. Time 3	0.1~6500.0S	*
	PD019	Decel. Time 3	0.1~6500.0S	*
	PD020	Accel. Time 4	0.1~6500.0S	*
	PD021	Decel. Time 4	0.1~6500.0S	*
	PD022	Reserved		
	PD023	Rev. Rotation Select	0: Rev Run forbidden; 1: Rev Run Enable	1
	PD024	STOP key select	0: STOP Invalid 1: STOP Valid	1
	PD025	Starting Mode	0: Start from Starting Frequency 1: Frequency track start	0
	PD026	Stopping Mode	0: Decelerating stop 1: Coasting stop	0
PD027	Starting Frequency	0.1~10.0 Hz	0.5	
PD028	Stopping Frequency	0.1~10.0 Hz	0.5	

PD031	DC Braking level		
PD029	DC Braking time at start	0.0~20.0%	2.0
PD030	DC Braking time at stop	0.0~25.0S	0.0
PD032	Frequency track time	0.0~25.0S	0.0
PD033	Current level for frequency track	0.0~20.0S	5.0
		0~200%	150
PD034	Voltage rise time during frequency track		0.5
PD035-PD040	Reserved		
PD041	Carrier frequency	0~15	*
PD042	Jogging Frequency	0.00~400.00 Hz	5.00
PD043	S-Curve Time	0~6500S	0
*PD044	Multi-input 1(FOR)	0: Invalid; 1:Run; 2: For rotation; 3:	02
*PD045	Multi-input 2(REV)	Rev rotation; 4: Stop; 5: FOR/REV.; 6:	03
*PD046	Multi-input 3(RST)	Jog; 7: Jog For rotation; 8: Jog Rev	14
*PD047	Multi-input 4(SPH)	Rotation; 9: Emergent stop; 10: Reset;	22
*PD048	Multi-input 5(SPM)	11:Reserved; 12: Overheat of heat sink or motor; 17: High speed; Middle speed; 19: Low speed; 20:	23
*PD049	Multi-input 6(SPL)	Multi-speed 1; 21: Multi-speed 2; 22: Multi-speed 3; 23: Ramp select 1; 24: Ramp select 2; 25: UP function; 26: DOWN function; 27: Counter 28: Counter reset; 29: Drawing; 32: PID Start	24
*PD050	Multi-output 1(DRV)	0: Invalid; 1: Run; 2: Fault indication; 3: Zero Speed; 4: Braking indication; 5: Set Frequency reach; 6: Arbitrary Frequency 1 reach;	01
*PD051	Multi-output 2(UPF)		05
*PD052	Multi-output 3(Terminals of FA,FB,FC)		02

	*PD053	Multi-output 4(Terminals of KA,KB)	7: Arbitrary Frequency 2 reach; 8: In Accel.; 9: In Decel.; 10: Inverter Overload alarm; 11: Motor Overload alarm; 12: Over-torque alarm; 13: Low voltage alarm; 14: Single stage end indication; 15: Process end indication; 16: Counter reach; 27: Drawing reach; 28:PID lower limit alarm; 29: PID upper limit alarm; 30: Fan act; 31: Reserved; 32: Braking resistor act	00
	PD054	Multi-output 5(AM)	Output of digital frequency signals	0
	PD055	AM Analog output Gain	0.0~100.0%	100
	PD056	Skip Frequency 1	0.00~400.00 Hz	0.00
	PD057	Skip Frequency 2	0.00~400.00 Hz	0.00
	PD058	Skip Frequency 3	0.00~400.00 Hz	0.00
	PD059	Skip Frequency Range	0.00~2.00 Hz	0.5
	PD060	Uniform Frequency 1	0.00~400.00 Hz	0.00
	PD061	Uniform Frequency 2	0.00~400.00 Hz	0.00
	PD062	Uniform Frequency Range	0.10~10.00 Hz	0.50
	PD063	Timer 1 time	0~10.0	0.01
	PD064	Timer 2 time	0~100	0.01
	PD065	Counting value set	00~65500	00
	PD066	Intermediate Counter	0~65500	0
	PD067-PD 069	Reserved		
Appl icabl e Para mete rs	PD070	Analog Input	0~10	0
	PD071	Analog Filtering Constant	0~50	20
	PD073	Lower Analog Frequency Bias Direction at Lower Frequency	0.00~400.00 Hz 0: Positive direction 1: Negative direction	0 0
	PD072 PD074	Higher Analog Frequency Bias Direction at Higher Frequency	0.00~400.00 Hz 0: Positive direction 1: Negative direction	50.00 0
	PD076	Analog Negative Bias Reverse	0: Not allowable. 1: Allowable.	0

PD077	Up/Down Function	0: Not memorized 1: Memorized	1
PD078	Up/Down Speed	0: 0.01HZ 1: 0.1HZ	0
PD079	Reserved		
PD080	PLC Operation	0: Normal run; 1: External control 4-speed; 2: External control multi-speed; 3: Disturbance; 4: Internal control multi-speed; 5: Drawing	0
PD081	AutoPLC	0: Stop after running for one cycle; 1: Cycling run; 2: Auto stop after running for one cycle (STOP for intervention); 3: Auto Run and Cycling (STOP for intervention)	0
PD082	PLC rotation Direction	0~255 (0: For 1: Rev)	0
PD083		0~255 (0: For 1: Rev)	
PD084	PLC Ramp Time	0~65535	0
PD085		0~65535	
PD086	Frequency 2	0.00-400.00 Hz	15.00
PD087	Frequency 3	0.00-400.00 Hz	20.00
PD088	Frequency 4	0.00-400.00 Hz	25.00
PD089	Frequency 5	0.00-400.00 Hz	30.00
PD090	Frequency 6	0.00-400.00 Hz	35.00
PD091	Frequency 7	0.00-400.00 Hz	40.00
PD092	Frequency 8	0.00-400.00 Hz	0.50
PD093	Frequency 9	0.00-400.00 Hz	10.00
PD094	Frequency 10	0.00-400.00 Hz	15.00
PD095	Frequency 11	0.00-400.00 Hz	20.00
PD096	Frequency 12	0.00-400.00 Hz	25.00
PD097	Frequency 13	0.00-400.00 Hz	30.00
PD098	Frequency 14	0.00-400.00 Hz	35.00
PD099	Frequency 15	0.00-400.00 Hz	40.00
PD100	Frequency 16	0.00-400.00 Hz	45.00

	PD101	Timer 1	0.0-6500.0S	10.0
	PD102	Timer 2	0.0-6500.0S	10.0
	PD103	Timer 3	0.0-6500.0S	0.0
	PD104	Timer 4	0.0-6500.0S	0.0
	PD105	Timer 5	0.0-6500.0S	0.0
	PD106	Timer 6	0.0-6500.0S	0.0
	PD107	Timer 7	0.0-6500.0S	0.0
	PD108	Timer 8	0.0-6500.0S	0.0
	PD109	Timer 9*	0.0-6500.0S	0.0
	PD110	Timer 10	0.0-6500.0S	0.0
	PD111	Timer 11	0.0-6500.0S	0.0
	PD112	Timer 12	0.0-6500.0S	0.0
	PD113	Timer 13	0.0-6500.0S	0.0
	PD114	Timer 14	0.0-6500.0S	0.0
	PD115	Timer 15	0.0-6500.0S	0.0
	PD116	Timer 16	0.0-6500.0S	0.0
Category	Code	Functions	Set Range & Function Explanation	Factory Setting
	PD117	AutoPLC Memory	0~1	0
	PD118	Over-voltage Stall Prevention	0: Invalid 1: Valid	1
	PD119	Stall Prevention Level at Accel.	0~200%	150
	PD120	Stall Prevention Level at Constant Speed	0~200%	0
	PD122	Stall Prevention Level at Decel.	0~200%	150
	PD123	Over-torque Detect Mode	0~3	0
	PD124	Over-torque Detect Level	0~200%	0
	PD125	Over-torque Detect Time	0.1~20.0S	1.0
	PD127-PD129	Reserved		
	PD130	Number of Auxiliary Pump	0~2	0

	PD131	Continuous Operating Time of Aux. Pumps	1~9000mim	1
	PD132	Interlocking Time of Aux. Pumps	1~250s	5s
	PD133	High Speed Running Time	1~250s	60s
	PD134	Low Speed Running Time	1~250s	60s
	PD135	Stopping Voltage Level	1~150%	95%
	PD136	Lasting Time of Stopping Voltage Level	1~250s	30s
	PD137	Wakeup Level	1~150%	80%
	PD138	Sleep Frequency	0.00~400.0	20.00
	PD139	Lasting Time of Sleep Frequency	1~250s	20s
	PD140	Reserved		
	PD141	Rated Motor Voltage	Set according to Motor nameplate Set according to Motor nameplate 02—10 00—9999	*
	PD142	Rated Motor Current		*
	PD143	Motor pole number.		04
	PD144	Rated Motor Revolution		1440
	PD145	Auto Torque Compensation	0.1—10.0 %	2.0%
	PD146	Motor no-load current	0—99	40
	PD147	Motor slip compensation	0.0—10.0	0.0
	PD148-PD149	Reserved		
	PD153	Restart after Instantaneous Stop	0: Invalid 1: Frequency track 0.1~5.0S 0—10 0: Invalid 1: Valid 0~10%	0
	PD154	Allowable Power-Breakdown Time		0.5
	PD155	Number of Abnormal Restart		00
	PD150	Auto Voltage Regulation		1
	PD151	Auto Energy Saving		0

	PD156	Proportional Constant (P)	0.0~1000.00%	100%
	PD157	Integral Time (I)	0.1~3600.00S	5.0
	PD158	Differential Time (D)	0.01~10.00S	0
	PD159	Target value	0.0~100.0%	0
	PD160	Target value select	0: set by the operator 1: set by external terminals (0-10V)	0
	PD161	PID upper limit	0~100%	100%
	PD162	PID lower limit	0~100%	0%
	PD163	Communication Addresses	0-250	0
	PD164	Communication Baud Rate	0-3	1
	PD165	Communication Data Method	0-5	0
	PD170	Display Items	0-5	
	PD171	Display Items Open	0-7	0
	PD166	Voltage Rating of Inverter	Set according to the model	0
	PD174	Rated Current of Inverter	Set according to the model	*
	PD181	Software Version		*
	PD177	Fault Record 1		—
	PD178	Fault Record 2		—
	PD179	Fault Record 3	Note: — means no fault record.	—
	PD180	Fault Record 4		—
	PD172	Fault Clear	00—10 (01 for Fault Clear)	00
	PD175	Inverter Model		
	PD176	Inverter Frequency Standard	0: 50Hz 1: 60Hz	0
	PD182	Manufacture Date	Year: Month: Week	*
	PD183	Serial No.		*

. Descriptions of Functions

PD000	Parameter Lock		**
	Set Range: 0—1	Unit: 1	Factory Setting: 0

0: Invalid.

1: Valid, i.e. the parameters are locked. Except this parameter other parameters can **not** be changed.

This parameter is set to prevent non-maintenance personnel from setting other parameters by mistake. After the parameters are locked the operating frequency can be changed by pressing Δ or ∇ .

PD001	Source of Operation Commands		
	Set Range: 0—2	Unit: 1	Factory Setting: 0

0: Set by the Operator

Operation commands are given via the digital operator.

1: Set by external terminals.

Operation commands are given via external terminals, i.e. multi-input terminals

2: Set by communication ports.

Operation commands are given via communication ports.

PD002	Source of Operating Frequency		
	Set Range: 0—2	Unit: 1	Factory Setting: 0

0: Set by the operator. Operating frequency is given via the digital operator.

1: Set by external terminals. Operating frequency is controlled by analog signals input via external terminals. The signal type is determined by PD070. For the related parameters refer to PD070-PD076.

2: Set by communication ports. Operating frequency is given via the serial communication.

PD003	Main Frequency		**
	Set Range: 0.00—400.00 Hz	Unit: 0.01 Hz	Factory Setting: 0.00

In the digital operator mode, the inverter will run at the set value of PD003. During running, the operating frequency can be changed by pressing \blacktriangle or \blacktriangledown . During multi-speed running, the main frequency is taken as the frequency of Speed 1.

In the external control multi-speed mode, if PD002 is set to 1, i.e. given by an external terminal, Speed 1 will be given by the analog of the external terminal.

The setting of main frequency is limited by the maximum operating frequency.

The related parameters of PD002, PD080 are adjustable during operation.

PD004	Base Frequency		
	Set Range: 0.01—400.00 Hz	Unit: 0.1Hz	Factory Setting: 50.00

This parameter must be set according to the rated frequency of operating voltage on the motor's nameplate. Under normal conditions do not change the set value of base frequency at will. If it is

equipped with a special motor this value should be set properly according to the characteristics of the motor's parameters. Otherwise it may cause the damage to the equipment.

PD005 Max. Operating Frequency

Set Range: 10.00—400.00 Hz Unit: 0.01 Hz Factory Setting: 50.00

This parameter is set for the maximum operating frequency of the inverter.

The following are several curves and set values often used for reference. Specific curves must be set according to concrete characteristics of mechanical load.

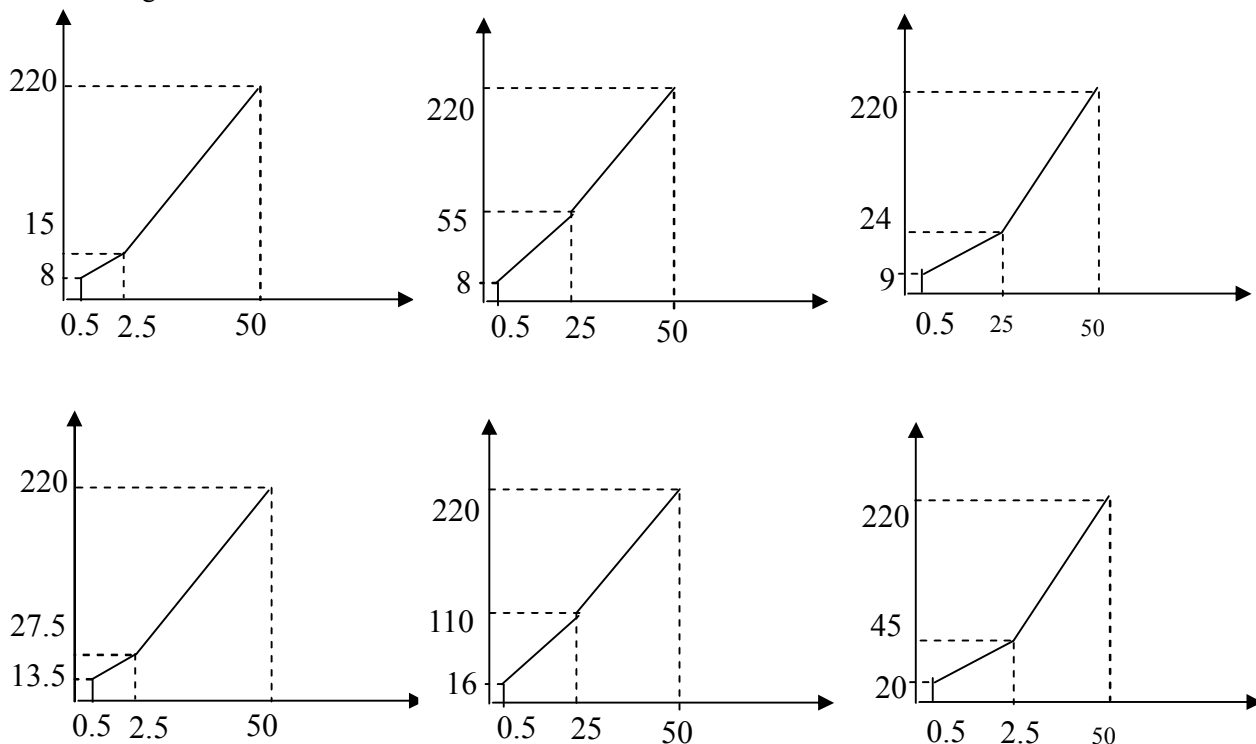

Curve of constant torque

Curve of lower torque

Curve of higher torque

PD006 Intermediate Frequency

Set Range: 0.01—400.00 Hz Unit: 0.01 Hz Factory Setting: 2.50

Note: **** means this parameter is adjustable during operation.**

This parameter is set for intermediate frequency of arbitrary V/F curve. If it is set improperly, it will cause over-current or under-torque of the motor, or even tripping of the inverter.

This set value of intermediate frequency is limited by the set value of base frequency.

PD007 Min. Frequency

Set Range: 0.1—20.00 Hz Unit: 0.01 Hz Factory Setting: 0.50

This parameter is set for the min. starting frequency of V/F curve.

The following table has specific factory settings of V/F curve, accel./decel., time and carrier for the inverter of A series:

PD008	Max. Voltage	Set Range: 0.1—*	Unit: 0.1V	Factory Setting: 220/380V
-------	--------------	------------------	------------	---------------------------

This parameter should be set according to the rated value of the motor's nameplate. The factory setting is 380V for 380V class motor and 220V for 220V class motor. The setting range of this parameter is restricted by the voltage rating of the inverter. In case of the motor relatively far away from the inverter this set value can be increased properly.

PD009	Intermediate voltage	Set Range: 0.1—500.0V	Unit: 0.1V	Factory Setting: 15/27.5
-------	----------------------	-----------------------	------------	--------------------------

This parameter is set for an intermediate voltage value of arbitrary V/F curve. If it is set improperly, it will cause over-current or under-torque of the motor, or even tripping of the inverter. When the intermediate frequency is increased the voltage will increase the output torque and at the same time also the output current. When changing this parameter please pay attention to monitoring the output current to avoid the inverter's tripping due to over-current.

The factory setting of intermediate voltage for 220V class inverter is 15, while the factory setting of intermediate voltage of 380V class inverter is 27.5.

This set value of intermediate voltage is limited by the set value of max voltage. When the voltage is increasing to a certain value at intermediate frequency the torque compensation will lose its function. When adjusting this parameter the output current of the inverter should be increased from low to high slowly according to the load of machines until it meets the starting requirement. Do not be quick to increase it by large amplitude. Otherwise it might cause the tripping of the inverter or the damage of the machines.

PD010	Min. Voltage	Set Range: 0.1—50.0V	Unit: 0.1V	Factory Setting: *
-------	--------------	----------------------	------------	--------------------

This parameter is set for the min. starting voltage of V/F curve.

The factory setting of min. voltage for 220V class inverters is 8, and the factory setting of min.voltage for 380V class inverters is 13.5.

This set value is limited by the voltage at the max. frequency.

Code Model	PD009	PD010	PD008	PD015	PD041	Code Model	PD009	PD010	PD008	PD015	PD041
A00D423B	15.0	7.5	5	5	9	A003043B	17	8.5	30	30	4
A0D7523B	14.0	7	8	8	9	A003743B	16	8	35	35	4
A01D523B	14.0	7	10	10	8	A004543B	16	8	40	40	4
A02D223B	13.0	6.5	10	10	8	A005543B	15	7.5	45	45	3
A03D723B	13.0	6.5	15	15	7	A007543B	15	7.5	50	50	3
A05D523B	12.0	6.0	15	15	6	A009043B	14	7	75	75	2
A07D523B	11.0	5.5	20	20	6	A011043B	14	7	100	100	2
A001123B	10.0	5.0	25	25	5	A013243B	13	6.5	150	150	2
A001523B	10.0	5.0	30	30	5	A016043B	13	6.5	150	150	2
A18D523B	9.0	4.5	35	35	5	A018543B	12	6	200	200	2

A002223B	9.0	4.5	50	50	4	A020043B	12	6	200	200	2
A0D7543B	22	11	8	8	9	A022043B	11	5.5	250	250	2
A01D543B	22	11	10	10	8	A025043B	11	5.5	250	250	2
A02D243B	21	10.5	15	15	8	A028043B	11	5.5	250	250	2
A03D743B	21	10.5	15	15	7	A030043B	10	5	250	250	2
A05D543B	20	10	15	15	6	A031543B	10	5	250	250	2
A07D543B	20	10	20	20	6	A034543B	10	5	250	250	2
A001143B	19	9.5	20	20	5	A037543B	10	5	250	250	2
A001543B	19	9.5	20	20	5	A040043B	10	5	250	250	2
A18D543B	18	9	25	25	5	A041543B	10	5	250	250	2
A002243B	18	9	25	25	5						

- Note: ① Ramp Time 2 = Ramp Time 1 x 2
 ② Ramp Time 3 = Ramp Time 2 x 2
 ③ Ramp Time 4 = Ramp Time 3 x 2
 ④ Min.Voltage Value = Intermediate Voltage Value/2
 ⑤ The intermediate frequency is 2.5 for the system of 50Hz.
 ⑥ The intermediate frequency is 3.0 for the system of 60Hz.

PD011	Frequency Lower Limit	**
	Set Range: 0.00—400.00	Unit: 0.01 Hz Factory Setting: 0.00

This is set for preventing workers from false operation to avoid over-heat or some other mechanical faults, which might be caused due to too low operating frequency.
 The setting of Frequency Lower Limit must be less than the set value of Frequency Upper Limit.

PD012	Reserved
-------	----------

PD013	Parameter Reset	
	Set Range: 00—10	Unit: 1 Factory Setting: 00

When the value for a parameter is set improper or is abnormal for some reasons this parameter can be set to 08 to restore it to the factory setting and then reset. After the parameters are locked (in case of PD000=1) the parameters can't be reset. They can only be reset after unlock. For related parameters refer to PD000.

PD014	Accel. Time 1	**
	Set Range: 0.1—6500.0S	Unit: 0.1S Factory Setting: *
PD015	Decel. Time 1	**
	Set Range: 0.1—6500.0S	Unit: 0.1S Factory Setting: *
PD016	Accel. Time 2	**
	Set Range: 0.1—6500.0S	Unit: 0.1S Factory Setting: *
PD017	Decel. Time 2	**
	Set Range: 0.1—6500.0S	Unit: 0.1S Factory Setting: *

PD18	Accel. Time 3			**
	Set Range: 0.1—6500.0S	Unit: 0.1S	Factory Setting:	*
PD019	Decel. Time 3			**
	Set Range: 0.1—6500.0S	Unit: 0.1S	Factory Setting:	*
PD020	Accel. Time 4			**
	Set Range: 0.1—6500.0S	Unit: 0.1S	Factory Setting:	*
PD021	Decel. Time 4			**
	Set Range: 0.1—6500.0S	Unit: 0.1S	Factory Setting:	*

Ramp-up time means the time needed for the inverter to increase the frequency from 0Hz to the maximum operating frequency (See t1 in the diagram). Ramp-down Time means the time needed for the inverter to decrease the frequency from the maximum operating frequency to 0Hz (See t2 in the diagram).

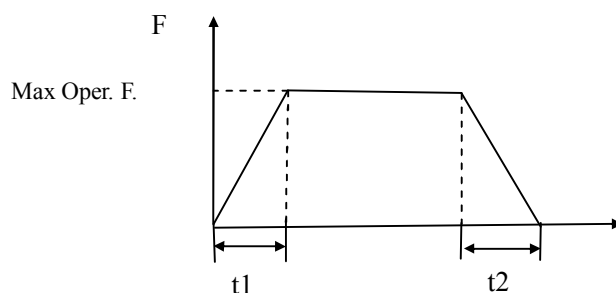

Note:

The versions previous to Vr2.0 took 50Hz as the base of ramp time.

HY-A Series inverter have altogether 4 Ramp Times. For Ramp Time 2,3,4 the user can select the different ramp up or down time through the external terminals or switching of ramp time according to the actual needs. In the internal control multi-speed operation, different ramp time can be selected through easy PLC.

Generally the default of the inverter is Ramp Time 1, which is factory set depending on the model. Ramp Time 4 is for the jogging ramp time. For the factory setting of parameters refer to the table in PD007.

The related parameters: PD044~PD049 and P084~PD085

P022	Factory Reserved
------	------------------

PD023	Rev Rotation Select		
	Set Range: 0—1	Unit: 1	Factory Setting: 1

0: Rev Rotation disable

1: Rev Rotation Enable

This function is suitable for the motor, which is not allowed to rotate reversely, to prevent workers from false operation. When the reverse rotation is disabled, the motor can only rotate forward, not reverse.

PD024	STOP key	Set Range: 0—1	Unit: 1	Factory Setting: 1
-------	----------	----------------	---------	--------------------

0: STOP invalid.

1: STOP valid.

This parameter set is only valid when PD001 is set to 1 or 2.

When the control mode is set for external terminals or communication control, STOP key on the panel can be chosen to be valid or invalid. When choosing it as valid, STOP key can stop the inverter in running. When it needs to restart, the former running signal must be released before restarting the inverter.

PD025	Starting Mode	Set Range: 0—1	Unit: 1	Factory Setting: 0
-------	---------------	----------------	---------	--------------------

Two starting modes are available for the needs of different equipment.

0: Start from the starting frequency.

When PD029 is set to 0, i.e. DC braking is invalid at start, it starts running from the starting frequency. When PD029 is set to any non-zero value, i.e. DC braking is valid at start, it first performs a DC braking at start, and then starts from the starting frequency.

For the related parameters refer to PD035, PD031 and PD029.

1: Start by frequency track

This setting can be used for the restarting of large inertia load. When restarting, the inverter will trace the former frequency from the set frequency downward. In case of large inertia equipment, when restarting, it can implement the running command and track the former frequency right away without waiting for the complete stop of the equipment to save time.

Note: When the inverter is restarted by frequency track, it will start tracking the frequency from its set frequency downward, and search it at the highest speed. When restarting, the current becomes higher, and over-current or stall may occur. So attention must be paid to the adjustment of current level of frequency track. Generally, PD033 is adjusted around 100. The concrete value can be set according to the characteristics of mechanical load.

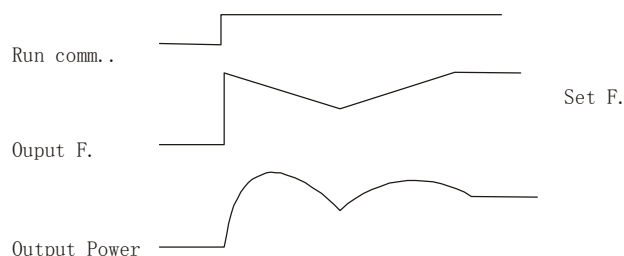

PD026	Stopping Mode	Set Range: 0—1	Unit: 1	Factory Setting: 0
-------	---------------	----------------	---------	--------------------

Two stopping modes are available for the needs of different equipment.

0: Decelerating Stop

When PD030 is set to 0, DC braking is invalid. When DC braking is invalid, the inverter will decelerate to the stopping frequency, and then stop outputs, and the motor will coast to stop. When

PD030 is set to any non-zero value, DC braking is valid, and the inverter will first decelerate to the stopping frequency, and then stop by DC braking.

DC braking at stop is usually used for high position stop or for positioning control. It must be noticed that frequent uses of DC braking will cause over-heat of the motor.

For the related parameters refer to PD028, PD031 and PD030.

1: Coasting Stop

When the inverter receives a STOP command, it will immediately stop output and the motor will coast to stop. When the coasting stop mode is selected, DC braking is invalid.

PD027	Starting Frequency	Set Range: 0.1—10.0 Hz	Unit: 0.1Hz	Factory Setting: 0.5
-------	--------------------	------------------------	-------------	----------------------

Starting frequency is the initial frequency when the inverter is started. If the starting frequency is set to 4.0Hz, the inverter will run between 4.0 Hz and the maximum operating frequency after its start at 4.0Hz . The actual maximum operating frequency is limited by the upper limit of frequency.

For the related parameters refer to PD025, PD031 and PD029.

PD028	Stopping Frequency	Set Range: 0.1—10.0 Hz	Unit: 0.1Hz	Factory Setting: 0.5
-------	--------------------	------------------------	-------------	----------------------

When stopping the inverter will decrease its frequency to the stopping frequency and then stop running or start DC braking to stop.

If PD030 is set to 0, DC braking is invalid at stop and the inverter will stop running.

If PD030 is set for valid, the inverter will stop by DC braking.

For the related parameters refer to PD026, PD031 and PD030.

PD029	DC Braking Time at Start	Set Range: 0.0—25.0S	Unit: 0.1S	Factory Setting: 0.0
-------	--------------------------	----------------------	------------	----------------------

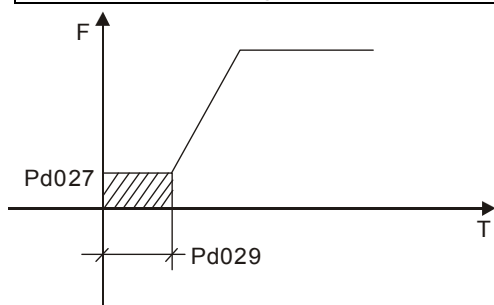

This parameter is set for DC Braking at start and the lasting time of DC Braking current to the motor. If it is set to zero it means DC braking is invalid.

DC braking at start is normally used in the application, in which the load is movable when the machine is at stop, such as windmill. Because of the load existing before the inverter drives, the motor is often in coasting with an uncertain rotation direction.

So the DC braking can be executed before starting the motor to prevent the inverter from tripping. This setting is valid only when PD025 is set to 0. For the related parameters refer to PD025, PD031 and PD027.

PD030	DC Braking Time at stop	Set Range: 0.0—25.0	Unit: 0.1S	Factory Setting: 0.0
-------	-------------------------	---------------------	------------	----------------------

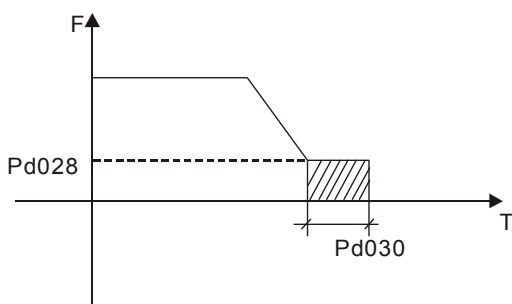

Note: When this parameter is set to any non-zero value it starts DC brake at stop and sends the DC braking time to the motor. DC braking at stop is

often used for a high-level stop or positioning control. When this parameter is set to zero it closes DC braking at stop.

This setting is valid when PD026 is set to 0. For the related parameters refer to PD026, PD028 and PD031.

PD031	DC Braking Voltage Level	Set Range: 0.0—20.0%	Unit: 0.1%	Factory Setting: 2.0
-------	--------------------------	----------------------	------------	----------------------

This parameter is set for the DC braking voltage to the motor at start and stop. It can be adjusted for different braking voltage. When adjusting the parameter it must be increased slowly from lower value to high value until the sufficient braking torque is achieved.

The voltage at maximum frequency is 100% voltage.

PD032	Frequency Track Time	Set Range: 0.1—20.0S	Unit: 0.1S	Factory Setting: 2.0
-------	----------------------	----------------------	------------	----------------------

This parameter is set as frequency track time when the inverter is started by frequency track after an external abnormality or temporary power breakdown. For starting or stopping of some large inertia load, if restarting a machine after its complete stop, it will waste much time because of its large inertia of load. But if the frequency track is started, it is not necessary to wait for the machine to come to a full stop for restart. The inverter will trace the frequency from high to low with the set frequency. After searching it will continue to accelerate to reach the set frequency.

PD033	Current Level for Frequency Track	Set Range: 0—200%	Unit: 1%	Factory Setting: 150
-------	-----------------------------------	-------------------	----------	----------------------

When the inverter is tracing the frequency this set value is taken as the level for output current. When the output current is higher than this level the inverter will decrease the frequency to restore the current below the level and then it will execute the frequency track again.

PD035	Up/down	Frequency Step Length: 0.01~2.5	Factory Setting: 0.01
-------	---------	---------------------------------	-----------------------

This parameter can be set in combination with PD078 for Up/Down of external control and the speed of increase and decrease.

In case of PD078=1 the step length of Up/Down=the set value of PD035, i.e., the range can be set to 0.01~25HZ.

In case of PD078=0 the step length of Up/Down=the set value of PD035 × 10, i.e., the range can be set to 0.1~25.0HZ.

PD041	Carrier Frequency	(Note: 0—15 corresponds to 0—20K Hz)	Set Range: 0—15	Unit: 1	Factory Setting: 5
-------	-------------------	--------------------------------------	-----------------	---------	--------------------

The carrier frequency has some relation with the electromagnetic noise of the motor, and meanwhile the level of the carrier frequency has certain relation with the heating capacity of the inverter and the interference to the environment. See the following table:

Carrier Frequency	Electromagnetic Noise	Heating Capacity	Interference to the Environment
-------------------	-----------------------	------------------	---------------------------------

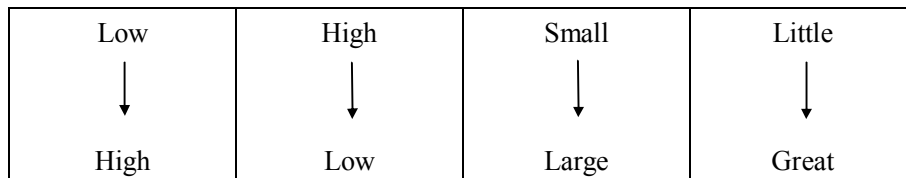

Carrier Frequency Corresponding Table

Set Value	0	1	2	3	4	5	6	7	8	9	10	11	12	13	14	15
Carrier Frequency KHz	0.7	1	1.5	2	3	4	5	7	8	9	10	11	13	15	17	20

As shown in the table above, the higher the carrier is, the lower the electromagnetic noise of the motor will be, but the stronger its interference to other systems will be and the greater the heating capacity of the inverter will have. Under higher ambient temperature and heavier load of the motor the carrier frequency should be decreased properly to improve the heat characteristics of the inverter.

The factory setting of carrier frequency is depending on the model. For specific data refer to the table in the description of PD007.

PD042	Jogging Frequency	**
	Set Range: 0.00—400.00 Unit: 0.01	Factory Setting: 5.00

The parameter set can realize the jogging function when the inverter is tested. The jogging operation can be only achieved through the external terminals, which can be set by multi-input terminals. Jogging frequency is limited by the frequency upper/lower limits. While the jogging function is implemented, other running commands are invalid. The ramp-up time of jogging frequency is set by Ramp-up Time 4. When the jog button is released the inverter will stop output immediately. In case of jogging function please set the corresponding multi-input terminals to 07 or 08.

This function is only valid at stop. It is invalid at running. For the related parameters refer to PD044-PD049.

PD043	S-Curve Time	
	Set Range: 0—6500S Unit: 1	Factory Setting: 1

This parameter can be set for no impact slow start or slow stop of the inverter when starting or stopping. When starting S-curve the inverter will make accelerating or decelerating curve of different speed rates according to Ramp Time.

When PD043 is set as 0, S-curve is invalid, i.e. it will accelerate or decelerate in linear. Without consideration of stall the actual accel/decal time = (PD008+PD043)/2. The parameter is only valid when PD008 is less than PD043.

PD044	Multi-input 1 (FOR function)	Factory Setting: 02
PD045	Multi-input 2 (REV function)	Factory Setting: 03
PD046	Multi-input 3 (RST function)	Factory Setting: 10
PD047	Multi-input 4 (SPH function)	Factory Setting: 17

PD048	Multi-input 5 (SPM function)	Factory Setting: 18
PD049	Multi-input 6 (SPL function)	Factory Setting: 19
	Set Range: 00—32	Unit: No

- 00: Invalid. The terminal is set for empty to prevent false actions.
- 01: RUN Running. It can be combined with other terminals to compose multiple control modes.
- 02: FOR Forward Rotation
- 03: REV Reverse Rotation
- 04: STOP Stopping
- 05: FOR/REV Switching of FOR/REV rotation
- 06: JOG Jogging
- 07: Jog FOR Rotation
- 08: Jog REV Rotation
- 09: Emergent Stop: Emergent stop. It can receive external emergent stop command or other fault signals
- 10: RST Reset. This terminal can be used for reset after a fault is removed.
- 11: Reserved
- 12: Over-heat of heat sink or motor: This contact can be used to detect over-heat of the heat sink or motor to protect the motor and inverter.
- 13: External Control Timer 1 Start: When the contact is closed, the timer will start and begin to count time. When the timer reaches the set point the corresponding multi-inputs will act.
- 14: External Control Timer 2 Start
- 15~16: Reserved
- 17: High speed High, middle and low speed can compose three kinds of operation mode with different frequencies. In the three terminals the high-end signal has priority. Low, Middle and High Speed are determined respectively by Frequency 2, 3, 4.
- 18: Middle speed
- 19: Low speed
- 20: Multi-speed 1 7-speed setting can be composed through Multi-speed 1, 2, 3.
- 21: Multi-speed 2
- 22: Multi-speed 3
- 23: Ramp Time 1: This terminal can be used to select the ramp time of the inverter.
- 24: Ramp Time 2: 4 kinds of ramp time are available for choice.
- 25: UP Function When the switch of this terminal acts the frequency setting of the inverter will be increased or decreased by one unit. When the switch of the terminal is hold the frequency will increase or decrease rapidly to a point and then increase or decrease
- 26: Down Function at even speed. When the power is up again after the power breakdown the changed frequency will not be memorized.
- 27: Counter Pulse When this terminal is set for the counter it can receive the pulse signal of $\leq 250\text{HZ}$ and counts.
- 28: Counter Reset When this contact acts it will clear the present counting values displayed, restore C00 and restart counting.

- * 29: Drawing Start When this contact is triggered the drawing action starts.
- * 31: AutoPLC Reset Suspend This contact can be used to achieve the function of AutoPLC clear suspend.
- * 32: PID Valid When this contact is closed, PID function starts. PID Function start is only valid during operation.

Note:

- ① The above functions with the mark of * are dedicated to the inverter of A series, which may be not available for P or J series.
- ② The functions of above 17 – 22 and 31 are not available for P series, and the function of above 32 is not available for J series.

Explanation:

1. Three multi-function terminals can be used for the connection method of three-wire system for the realization of switching of FOR/REV rotation, which is extensively applied in the cases of FOR/REV switching of photoelectric switches.

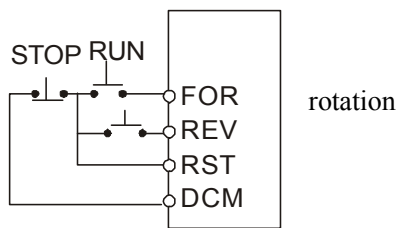

- ① Select FOR, REV and RST.
- ② Parameter setting:
 PD001=1 for external control PD044=02 for FOR
 PD045=03 for REV Rotation PD046=04 for Stop
- ③ Action Description:
 When triggering FOR, the inverter will rotate forward

(start);

When triggering REV, the inverter will rotate reverse;

When pressing STOP, the inverter will stop.

2. RUN, DCM, F/R can be used for Start, Stop and switching of FOR/REV:

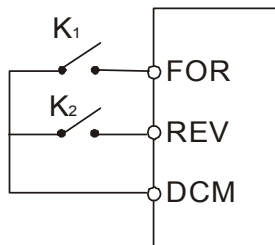

- ① Select FOR and REV
 - ② Parameter setting:
 PD001=1 for external control
 PD044=01 for RUN function
 PD045=05 for switching of F/R
- When K2 is opened it rotates forward, while K2 is closed it rotates reverse.

3. Description of Ramp Time 1 and 2:

- 1) This function is only valid when PD080 is set to 0, 1 and 2. Under the disturbance and internal control multi-speed it is invalid.
- 2) Any two multi-inputs can be combined for 4 kinds of ramp time for selection.
- 3) The related multi-inputs are set for Ramp Time 1, 2. Take the terminals of SPH and SPM as example, when SPH PD047 is set to 23 and SPM PD048 is set to 24, SPH and SPM are now

Ramp Time 1, 2.

SPH	SPM	Result
OFF	OFF	Ramp Time 1
ON	OFF	Ramp Time 2
OFF	ON	Ramp Time 3
ON	ON	Ramp Time 4

4. Function description of High, Middle and low speed terminals:

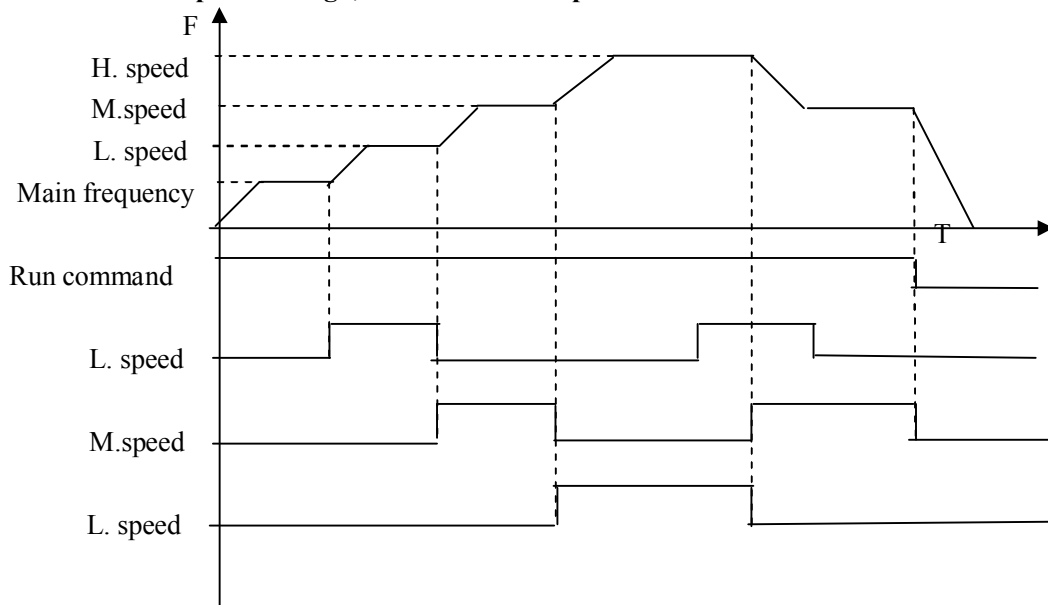

RUN	SPL	SPM	SPH	Result
ON	OFF	OFF	OFF	Main speed, the frequency runs at the set value of PD003.
ON	ON	OFF	OFF	Low speed, the frequency runs at the set value of PD086.
ON	ON/OFF	ON	OFF	Middle speed, the frequency runs at the set value of PD087.
ON	ON/OFF	ON/OFF	ON	High speed, the frequency runs at the set value of PD088.

Note:

- (1) This function is only valid when PD080 is set to 1, i.e. for 4-Speed of external control.
- (2) Low, middle and high speed frequency are determined by Frequency 2,3, 4.
- (3) Ramp time is determined by Ramp Select terminal.
- (4) When all high, middle and low speeds have signal inputs it will give priority in the sequence of high, middle and low speed.

5. Description of UP and DOWN Function:

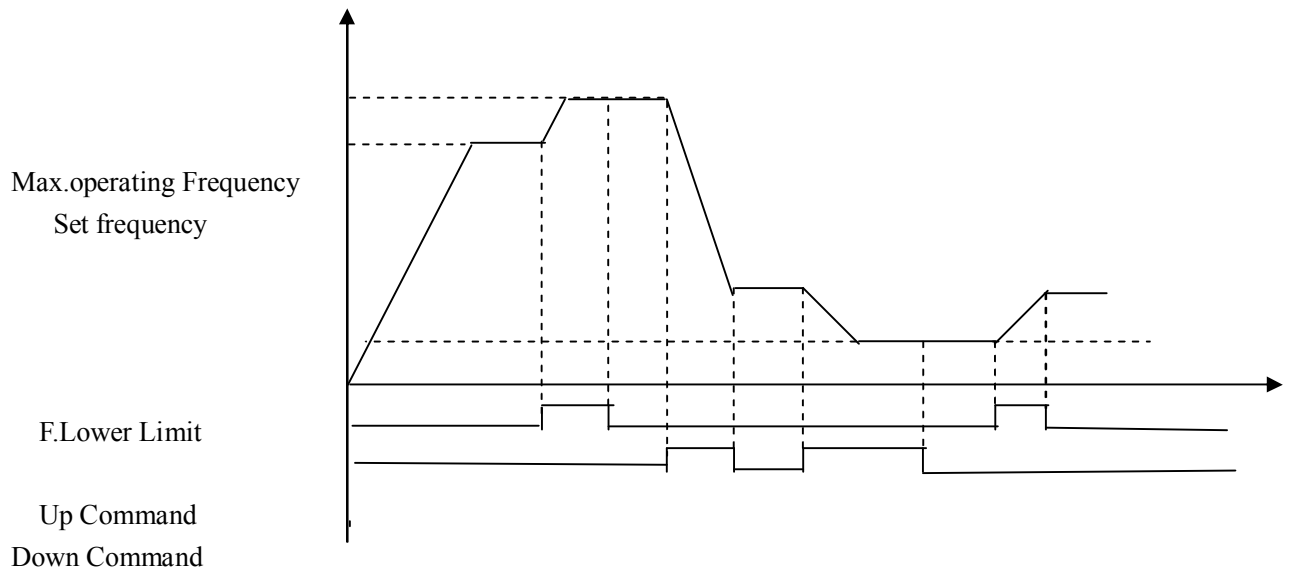

UP	DOWN	Result
ON	OFF	Frequency increase
OFF	ON	Frequency decrease
ON	ON	Not increase or decrease

Note:

- (1) The function of UP and DOWN is only valid when the operator is selected for the source of the operating frequency, i.e. PD002=0.
- (2) When the UP terminal is closed the frequency of the inverter will increase.
- (3) When the DOWN terminal is closed the frequency of the inverter will decrease.
- (4) When both UP and DOWN terminals are closed at the same time the frequency will neither increase nor decrease. It is regarded as invalid.
- (5) When the frequency reaches the max operating frequency it will stop increasing.
- (6) When the frequency reaches the min frequency or its lower limit, it will stop decreasing.
- (7) After a power breakdown the set value of PD003 will be memorized instead of the frequency.
- (8) When using the function of UP and DOWN, the keys of Δ ∇ of the panel are valid. After changing the values it needs to press SET (ENTER) key for confirmation and then the inverter can implement the action. Meanwhile the value will write to PD003, which will be memorized after a power breakdown.
- (9) When keeping pressing UP or DOWN, the frequency will increase or decrease rapidly to a point and then increase or decrease at even speed.
- (10) The value changed by UP or DOWN can be set through PD077 for confirmation of whether it should be memorized or not memorized. For details refer to PD077.

6. Function Description of Multi-speed 1, 2 and 3:

They are only valid when PD080 is set to 2. For details refer to PD080.

7. Function Description of Counter:

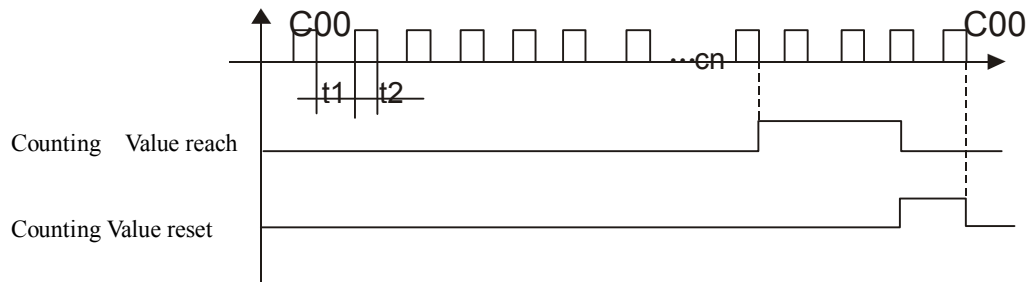

Note:

- (1) The signal width triggered should not be lower than 2 msec (t_1 、 $t_2 \geq 2\text{msec}$) .
- (2) When the counting value is reached the corresponding multi-output contact will act.
- (3) This counter can only count again after reset.
- (4) When reaching to 65535 the counter will not count again.

8. Description of AutoPLC Clear Suspend:

For details refer to 10. Example Application of AutoPLC Suspend in Appendix 1 and the description of related parameters in PD117.

* PD050	Multi-Output 1 (DRV function)	Factory Setting: 01**
* PD051	Multi-Output 2 (UPF function)	Factory Setting: 05
* PD052	Multi-Output 3 (FA, FB, FC function)	Factory Setting: 02
* PD053	Multi-Output 4 (KA, KB function)	Factory Setting: 00
	Set Range: 00—32	Unit: 1

- 00: Invalid: The terminal is set for no function to prevent false actions.
- 01: In Run: The contact will act when the inverter has output or receives the running command.
- 02: Fault Indication: The contact will act when the inverter detects abnormal conditions.
- 03: Zero Speed: The contact will act when the output frequency of the inverter is less than its starting frequency.
- 04: DC Braking indication: The contact will act when the inverter is in DC braking.
- 05: Set Frequency reach: The contact will act when the output frequency of the inverter reaches the set frequency.
- 06: Uniform Frequency 1 Reach: The contact will act when the output frequency of the inverter reaches the designated frequency (PD060).
- 07: Uniform Frequency 2 reach: The contact will act when the output frequency of the inverter reaches the designated frequency (PD061).
- 08: In Accel: The contact will act when the inverter is in ramp-up.
- 09: In Decel: The contact will act when the inverter is in ramp-down.
- 10: Inverter Over-load Alarm: The contact will act when the inverter detects over-load.
- 11: Motor Overload Alarm: The contact will act when the inverter detects over-load of the motor.

- 12: In Over-torque Detect: The contact will act when the inverter detects over-torque.
- 13: Low Voltage Alarm: The contact will act when the inverter detects low voltage.
- * 14: Single Step End: The contact will act and generate one pulse when the inverter finishes a single step in implementation of program operation.
- * 15: Process End: The contact will act and generate one pulse when the inverter finishes all the steps (i.e. after one cycle) in implementation of program operation.
- 16: Set Counter Reach: The contact will act when the inverter implements the external counter and the counting value is equal to the set value (PD065).
- 17: Middle Counter Reach: The contact will act when the inverter implements the external counter and the counting value is greater than or equal to the set value (PD066).
- 18: External Control Timer 1 reach: The contact will act when the timer reaches the set value.
- 19: External Control Timer 2 reach:
- 20: 4~20mA disconnected: When AI input signal is opened the contact will act.
- * 25: Auxiliary Pump 1: This contact controls the starting and stopping of auxiliary pumps. For details refer to Operation of Multi-pumps.
- * 26: Auxiliary Pump 2
- * 27: Drawing reach: The contact will act when the drawing action is finished. The contact will automatically reset when the inverter stops.
- * 28: PID Lower Limit Alarm: This contact will act when the PID feedback is smaller than the lower limit (the set value of PD162).
- * 29: PID Upper Limit Alarm: This contact will act when the PID feedback is greater than the upper limit (the set value of PD161).
- 30: Fan act: When the temperature of the inverter is increased or it is in running, this contact will act.
- 31: Electromagnetic Relay Act: When the contact pulls in, the corresponding multi-function terminal will act.
- 32: Braking Resistor Act: When the inverter is in running and the DC voltage reaches the braking voltage the contact will act.

Note:

- ① **The above functions with the mark of * are dedicated to the inverter of A series, which may be not available for P or J series.**
- ② **The functions of above 14, 15 and 27 are not available for P series, and the functions of above 25, 26, 28 and 29 are not available for J series.**

PD054	Multi-Output AM		**
	Set Range: 0—7	Unit: 1	Factory Setting: 0

Functions: Output terminal of digital frequency, generating pulse or 0—10V analog. In combination with PD055 it can be connected with a corresponding instrument with the measuring range below 10 to be used for external monitoring.

- 0: 0~10V analog output, corresponding to output frequency. 0~10V corresponds to 0~Maximum operating frequency
- 1: 0~10V analog output, corresponding to output current. 0~10V corresponds to 0~two times of the rated current of the inverter.

- 2: Analog output, corresponding to DC bus voltage. 0~10V corresponds to 0~1000V.
- 3: Analog output, corresponding to AC output voltage. 0~10V corresponds to 0~510V/255V.
 (Note: The machine type of three phase, 380V corresponds to 510V and the machine type of single phase, 220V corresponds to 255V)
- 4: Pulse Output, corresponding to operating frequency: 1 Pulse/Hz, (50% of capacity ratio)
- 5: Pulse Output, corresponding to operating frequency: 2 Pulse /Hz, (50% of capacity ratio)
- 6: Pulse Output, corresponding to operating frequency: 3 Pulse /Hz, (50% of capacity ratio)
- 7: Pulse Output, corresponding to operating frequency: 6 Pulse /Hz, (50% of capacity ratio)

PD055	AM Analog Output Gain		
	Set Range: 0.0—100.0%	Unit: 0.1%	Factory Setting: 100.0

This parameter can be used to adjust the output voltage value of Multi-output 6 to adapt to frequency meters with different measuring range and also used to correct a frequency meter. For example, for an externally connected frequency meter with the measuring range of 0~5V, a multi-function terminal can be used to display its operating frequency. Then it can be corrected with this parameter. It can be achieved by setting PD055=50 .

PD056	Skip Frequency 1		**
PD057	Skip Frequency 2		
PD058	Skip Frequency 3		
	Set Range: 0.00—400.00 Hz	Unit: 0.01Hz	Factory Setting: 0.0
PD059	Skip Frequency Range		**
	Set Range: 0.10—2.00 Hz	Unit: 0.01Hz	Factory Setting: 0.5

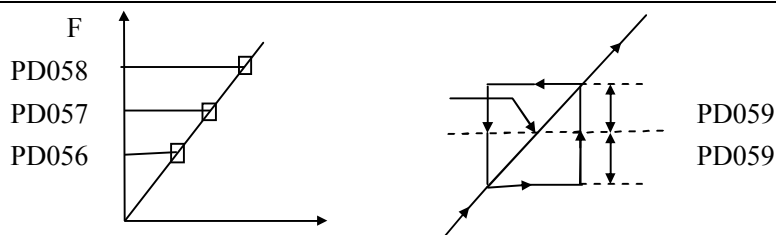

These three frequency skipping points are set for avoiding a mechanical resonance point. In case of PD059=0, all skip frequencies are invalid. The actual skip frequency range is two times that of PD059, as shown in the above diagram.

PD060	Uniform Frequency 1		**
PD061	Uniform Frequency 2		
	Set Range: 0.00—400.00 Hz	Unit: 0.01 Hz	Factory Setting: 0.00
PD062	Uniform Frequency Range		**
	Set Range: 0.00—10.00 Hz	Unit: 0.01 Hz	Factory Setting: 0.50

When the output frequency is more than the uniform frequency the corresponding multi-outputs will act. The uniform frequency range acts as a hysteresis loop.

When the inverter is in the operation of multi-pumps, PD060 (Uniform Frequency 1) is used as high speed frequency and PD061 is set as low speed operating frequency. The definitions of the corresponding multi-function contacts are changed.

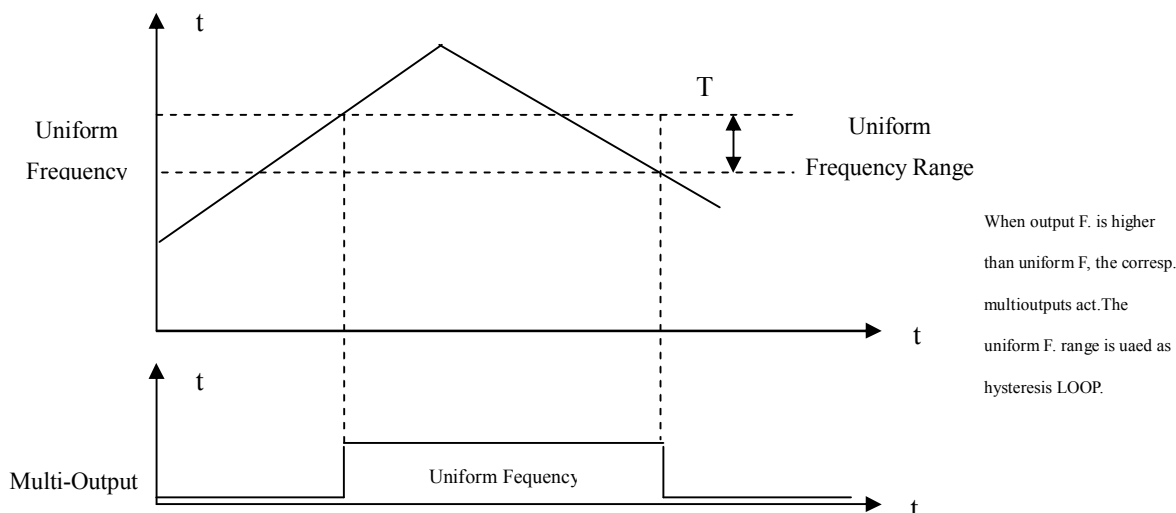

PD063	Timer 1 Time		
	Set Range: 0~10.00	Unit: 1	Factory Setting: 0.01
PD064	Timer 2 Time		
	Set Range: 0~100	Unit: 1	Factory Setting: 0

Timer 1 is a timer of 0.1s ~ 10.0s and Timer 2 is a timer of 1s ~ 100s. When the timer start at multi-inputs is closed (on) the timer starts to count time. When it reaches the set time the corresponding multi-output contact will act. When the timer start is opened (off) the timer time at the multi-output will be reset.

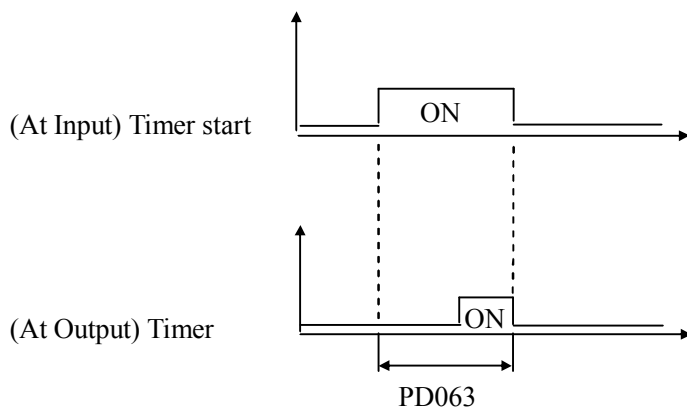

For example, set PD063=5.0s. When the external control terminal (Multi-Input) is valid the output terminal will be valid after five (5.0) seconds, the signal of which can be used to control other corresponding signals.

PD065	Counting Value		**
	Set Range: 0—65500	Unit: 1	Factory Setting: 0

An external terminal of multi-function can be used as a trigger for the counter. When the counter reaches the set value of PD065 the corresponding multi-output contact will act. After the counter is cleared and reset it will start counting again. A proximity switch or optoelectronic switch can be used for the triggering signals.

PD066	Intermediate Counter	Set Range: 0-65500	Unit: 1	Factory Setting: 0
-------	----------------------	--------------------	---------	--------------------

Refer to PD065.

PD070	Analog Input	Set Range: 0—10	Unit: 1	Factory Setting: 0
-------	--------------	-----------------	---------	--------------------

- | | | |
|-------------------|---------------------------|-----------------|
| 0: 0~10V | 1: 0~5V | 2: 0~20mA |
| 3: 4~20mA | 4: 0-10V 与 4-20mA stacked | 5: XIA |
| 6: (VI+XIA) /2 | 7: (3VA+XIA) /4 | 8: (XIA+XIB) /2 |
| 9: Max (XIA, XIB) | 10:Min (XIA,XIB) | |

This parameter can be set for different analog input signals.

When PD070=4, the output frequency = $1/2 (U/U_{max} + I/I_{max}) \times 50\text{Hz}$

Among which: U: Analog Voltage; U_{max} : Maximum Analog Voltage;

I: Analog Current; I_{max} : Maximum Analog Current.

For example, When +10V and 20mA are respectively entered for the analog input, the output frequency of the inverter is 50Hz.

PD071	Analog Filtering Constant	Set Range: 0-50	Unit: 1	Factory Setting: 20
-------	---------------------------	-----------------	---------	---------------------

The setting of this parameter is related to the analog responding speed. The higher the value of PD071 is set, the lower the analog responding speed will be.

PD073	Lower Analog Frequency	Set Range: 0.00—400.00 Hz	Unit: 0.01 Hz	Factory Setting: 0.00
PD075	Bias Direction at Lower Frequency	Set Range: 0—1	Unit: 1	Factory Setting: 0

0: Positive direction

1: Negative direction

Bias direction means the instruction of FOR/REV rotation command. Positive bias indicates forward rotation while negative bias indicates reverse rotation. For details refer to the diagram in PD076.

PD072	Higher Analog Frequency	Set Range: 0.00—400.00 Hz	Unit: 0.01Hz	Factory Setting: 50.00
PD074	Bias Direction at Higher Frequency	Set Range: 0—1	Unit: 1	Factory Setting: 0

0: Positive direction

1: Negative direction

Bias direction means the instruction of FOR/REV rotation command. Positive bias indicates forward rotation while negative bias indicates reverse rotation. For details refer to the diagram in PD076.

PD076	Analog Negative Bias Reverse	Unit: 1	Factory Setting: 0
Set Range: 0—1			

0: Negative bias Rev is not allowable.

1: Negative bias Rev is allowable.

The parameter group is set for the measuring range and zero point of the external analog terminals and can be combined for any kind of curve to control the operation of the motor.

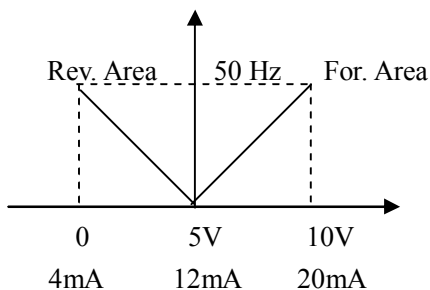

Setting: PD073=50 PD075=1 PD072=50
 PD074=0 PD076=1

Note: this curve can be easily used in complicated applications in combination with other curves. When using the instruction of FOR/REV run from external terminals is still valid. When switching, the curve will turn reverse.

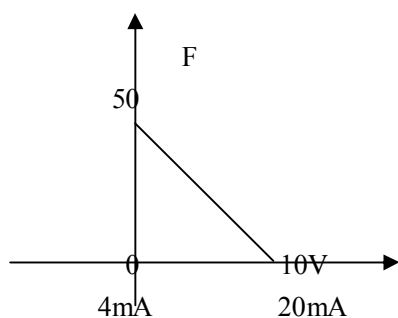

Setting: PD073=50 PD075=0 PD072=0
 PD074=0 PD076=0

Note: this curve is a kind of special application of reverse ramp setting. When using transmitter for the control of pressure, temperature and others and while the control has higher pressure and output signals but requiring the corresponding commands of stop or deceleration on the inverter this curve can satisfy the demand properly.

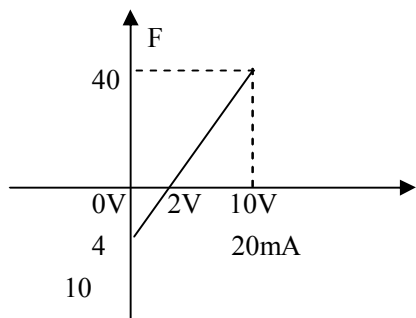

Setting: PD073=10 PD075=1 PD072=40
 PD074=0 PD076=1

Note: this method is used extensively. The user can use it flexibly.

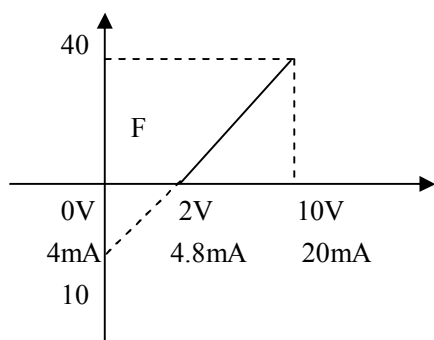

Setting: PD073=10 PD075=1 PD072=40
 PD074=0 PD076=1

Note; this curve is the extension of the above curve. 2V~10V (4.8mA~20mA) corresponds to 0Hz~40HZ; the signal of 0V~2V (4~4.8mA) is invalid. It can be used to avoid noise disturbance. In harsh environment it is better not to use signals below 1V for setting the operating frequency of the inverter.

PD077	UP/DOWN Function		
	Set Range: 0-1	Unit: 1	Factory Setting: 0

0: Not memorized 1: Memorized

This parameter can be set for the selection of whether the values changed by the UP or DOWN shall be memorized or not after stop. The changed values whether to be memorized or not means when they are changed by UP or DOWN during operation and the inverter is restarted after stop these changed values shall be memorized or not after restart. When PD077 is set to 0, the changed value will not be memorized and when it is set to 1, the changed values will be memorized. The set values of PD003 will be memorized after restart.

For the related parameters refer to PD044-PD049.

PD078	UP/DOWN Speed		
	Set Range: 0-1	Unit: 1	Factory Setting: 0

0: 0.01Hz. Minimum UP/DOWN speed is 0.01Hz.

1: 0.1Hz. Minimum UP/DOWN speed is 0.1Hz.

Through the changes of this set value the UP/DOWN speed unit can be adjusted to meet the needs of different customers.

PD080	PLC Operation		
	Set Range: 0—5	Unit: 1	Factory Setting: 0

*** This function is not available for the inverter of P series. Default is normal operation.**

0: Normal operation, i.e. the inverter is running in the normal control mode.

1: External control 4-Speeds (Refer to the function description and diagram of three terminals of high, middle and low speed in C050~C055)

2: External control multi-speeds

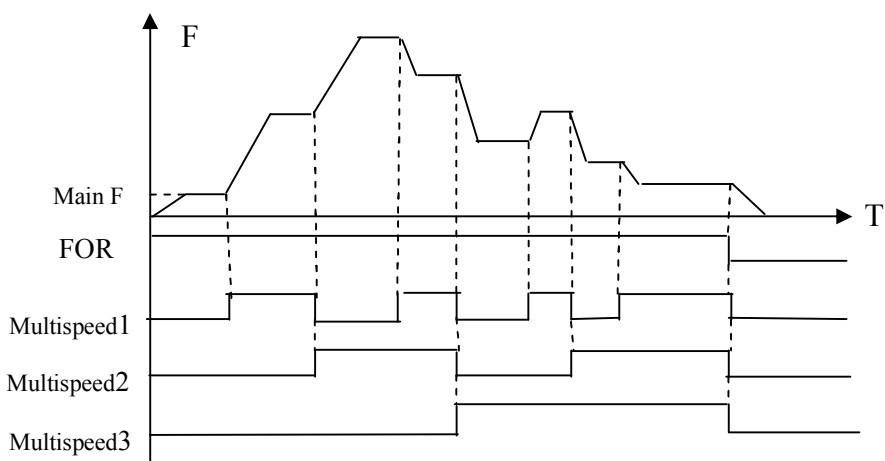

Multi-function Terminals			Results
Multi-speed 1	Multi-speed 2	Multi-speed 3	
OFF	OFF	OFF	Main frequency and frequencies are determined

			by PD003 or potentiometer.
ON	OFF	OFF	Multi-speed 1 and frequency are determined by PD086.
OFF	ON	OFF	Multi-speed 2 and frequency are determined by PD087.
ON	ON	OFF	Multi-speed 3 and frequency are determined by PD088.
OFF	OFF	ON	Multi-speed 4 and frequency are determined by PD089.
ON	OFF	ON	Multi-speed 5 and frequency are determined by PD090.
OFF	ON	ON	Multi-speed 6 and frequency are determined by PD091.
ON	ON	ON	Multi-speed 7 and frequency are determined by PD092.

Note:

- ① It is only valid to realize the external control 8-Speeds operation when Multi-inputs are set for Multi-speed 1, 2, 3 and PD080 is set to 2.
- ② Multi-speed 1, 2, 3 can be used to make up 7-Speeds and 8-Speeds adding the main frequency .
- ③ The frequencies of Speed Step 1 ~ Step 7 are determined by PD086~PD092.
- ④ Each ramp time is determined by the external multi-function terminal.
- ⑤ The directions of each program operation are determined by the external multi-function terminals.
- ⑥ The main frequency can be set in two ways. One method is to set it through PD003 and another is to set it through the potentiometer. When PD002 is set to 1 the frequency of Main Frequency is set by the potentiometer. For the related parameters refer to PD003, PD002 and PD086~PD092.

3: Disturbance (Traverse function)

This is a special parameter in the chemical fiber and printing and dyeing industries to realize the traverse function. Except the commands of stop, external faults and emergency stop all other commands are not accepted at running.

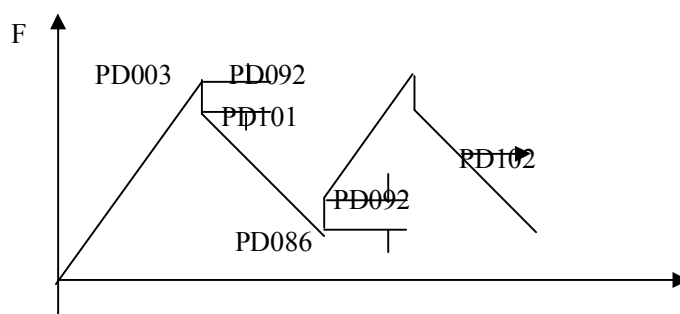

Note:

- ① The frequency at each inflection point is determined by PD003 and PD086.

- ② Skip Frequency is determined by PD092.
- ③ Running Time is determined by Timer PD101 and PD102.
- ④ The related parameters: PD003, PD086~PD102.

4: Internal control Multi-speeds

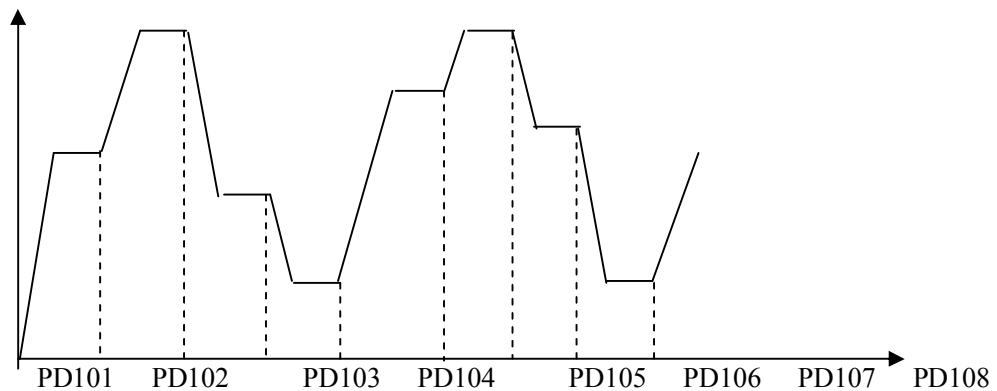

T

Note:

- ① Main speed and 7-speeds composes 8-speeds.
- ② The ramp time of each speed step is set by PLC Ramp Time CD079. Refer to the detail descriptions of CD079.
- ③ Running Time is set by Timer PD101~PD108. For the control steps not to be used the timer can be set to 0.
- ④ Running direction of each speed step is determined by CD078.
- ⑤ In the internal control multi-speed operation the running time and direction are determined by the setting of internal parameters. Any switching of external time and FOR/REV rotation is invalid.

5: Drawing

This is a special parameter for the constant speed of unwinding and rewinding. By using this function the linear speed constant in certain accuracy can be realized.

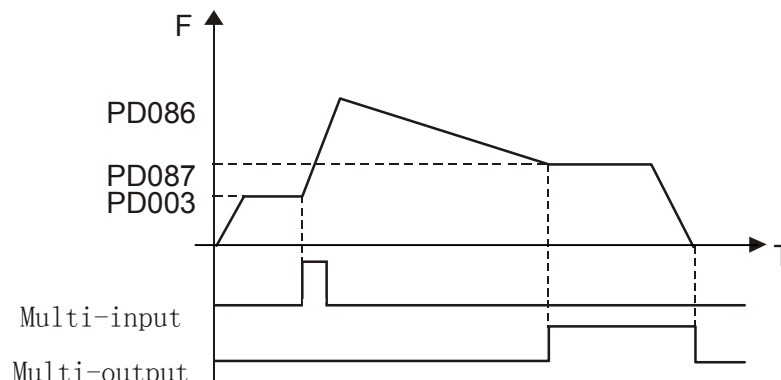

Note:

- ① Through triggering of the external multi-function terminal the drawing action begins.
- ② In implementation of the drawing action the actual running time is $T=PD101 \times 10$.
- ③ when the drawing action is finished the inverter will run at the constant speed of PD087 and the corresponding multi-output contact will act at the same time. Until receiving the STOP command the inverter will stop running and the multi-output contact will reset.

PD081 Auto PLC		
Set Range: 0—3	Unit: 1	Factory Setting: 0

*** This function is not available for the inverter of P series.**

- 0: Stop after the program runs one cycle.
1: Cycling running.
2: Stop after it runs one cycle automatically (STOP for intervention) .
3: Auto running and cycling (STOP for intervention)

This parameter setting is only valid when PD080 is set to 4. For relevant parameters refer to PD003, PD080 and CD078~PD108.

Explanation:

1. Stop after the program runs one cycle.

When the command of auto program operation is given, the inverter will run with each set value of internal parameters. It will run for one cycle and then stop automatically. The inverter will not restart and run until it receives another command of operation.

2. Cycling run.

When the command of operation is given, the inverter will run in sequence with the frequency of every speed step and running time set by each of the internal parameters and will recycle. During the cycling run, except the commands of stop, external faults and emergency stop, all other commands will not be accepted.

3. Stop after it runs one cycle automatically (STOP for intervention)

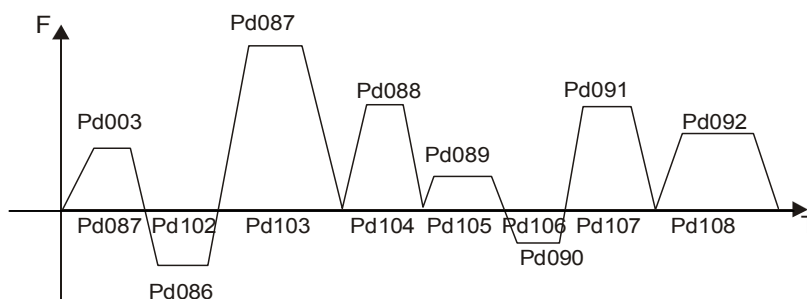

Note:

- ① When the command of auto program operation is given the inverter will run with each parameters. But it will stop first and then restart at changing of each step and will stop automatically after running for one cycle. The inverter will not restart and run until it receives another command of operation.
- ② The frequencies of each speed step are set by PD003 and PD086~PD092.

- ③ The running times of each speed step are set by PD101~PD108.
- ④ The running direction is set by P082

PD082 PLC Running Direction Set Range: 0—255 Unit: 1 Factory Setting: 0

This parameter is only valid when PD080 is set to 4. This parameter setting determine the running direction of each frequency of PD086~PD092 and PD003 in the program operation. The setting method is as follows:

The rotation direction is set first in the binary 8 bits mode, and then converted to a decimal value for the setting of this parameter. For instance:

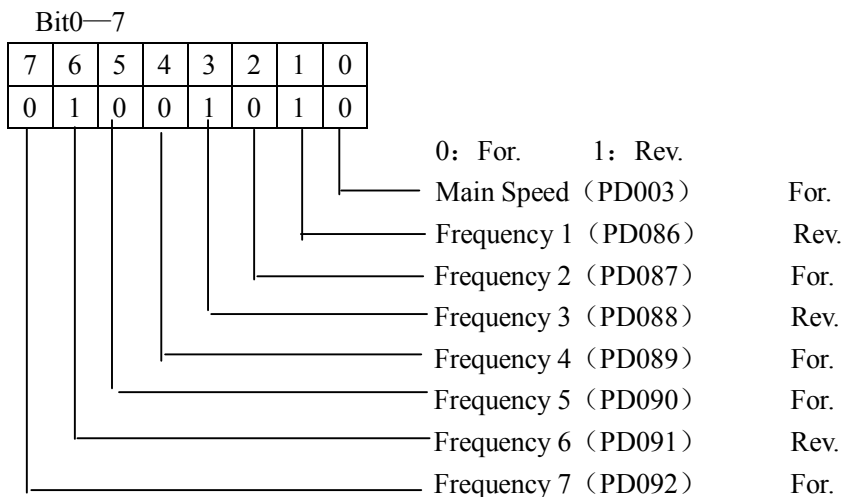

The parameter value 01001010 is converted to a decimal value:

$$1 \times 2^6 + 1 \times 2^3 + 1 \times 2^1 = 64 + 8 + 2 = 74$$

Then PD082=74

PD084 PLC Ramp Time Set Range: 0~65535 Unit: 1S Factory Setting: 0
--

This parameter is only valid when PD080 is set to 4.
 This parameter is set to determine the ramp time values for Step 1~4 of the internal control multi-speed. The setting method is as follows:

- ① Determine each Ramp Time in the binary 2 bit mode

Bit1	Bit0	Ramp Time
0	0	Ramp Time 1 PD014, PD015
0	1	Ramp Time 2 PD016, PD017
1	0	Ramp Time 3 PD018, PD019
1	1	Ramp Time 4 PD020, PD021

- ② Determine the Ramp time of each speed step in the binary 16 bit mode

Step 8	Step 7	Step 6	Step 5	Step 4	Step 3	Step 2	Step 1
t8	t7	t6	t5	t4	t3	t2	t1

0	0	0	0	0	0	0	0	0	0	1	1	0	0	0	1	1
---	---	---	---	---	---	---	---	---	---	---	---	---	---	---	---	---

- t1 Select Ramp Time 4
- t2 Select Ramp Time 1
- t3 Select Ramp Time 3
- t4 Select Ramp Time 2
- t5 Select Ramp Time 1
- t6 Select Ramp Time 1
- t7 Select Ramp Time 1
- t8 Select Ramp Time 1

The setting value:

$$1 \times 2^0 + 1 \times 2^1 + 1 \times 2^5 + 1 \times 2^6 = 99$$

So PD084 is set to 99

Attach: $2^0=1$ $2^1=2$ $2^2=4$ $2^3=8$

$2^4=16$ $2^5=32$ $2^6=64$ $2^7=128$

PD086	Frequency 2	Factory Setting	15**
PD087	Frequency 3	Factory Setting	20
PD088	Frequency 4	Factory Setting	25
PD089	Frequency 5	Factory Setting	30
PD090	Frequency 6	Factory Setting	35
PD091	Frequency 7	Factory Setting	40
PD092	Frequency 8	Factory Setting	0.5
Set Range: 0.00—400.00 Hz		Unit: 0.01 Hz	

This parameter is set in combination of the multi-inputs to select 4-speeds of external control, multi-speeds of external control or multi-speeds of internal control. For the relevant parameters refer to the description of PD080 and PD101~PD108.

PD101	Timer 1	Factory Setting	10.0**
PD102	Timer 2	Factory Setting	10.0
PD103	Timer 3	Factory Setting	0.0
PD104	Timer 4	Factory Setting	0.0
PD105	Timer 5	Factory Setting	0.0
PD106	Timer 6	Factory Setting	0.0
PD107	Timer 7	Factory Setting	0.0
PD108	Timer 8	Factory Setting	0.0
Set Range: 0.0—6500.0S		Unit: 0.1S	

This parameter is set for the internal control multi-speeds and the running time of drawing function. For the relevant parameter refer to PD080 and PD086~PD102.

PD117	AutoPLC Memory Function
Set Range: 0—1 Factory Setting: 0	

0: Not memorized

1: Memorized

This parameter is set to determine whether the inverter is to realize the suspending function in AutoPLC mode. In case of PD117=1 it can memorize the status in which the inverter is running and will memorize it at stop or fail. It will continue to run when returning to normal. In case of PD117=0 it will not memorize. For specific applications refer to Example Application 10 in Appendix 1.

PD118	Over-voltage Stall Prevention	Set Range: 0—1	Unit: 1	Factory Setting: 1
-------	-------------------------------	----------------	---------	--------------------

0: Over-voltage stall prevention invalid

1: Over-voltage stall prevention valid.

When the inverter is in deceleration, due to the effect of load inertia, the motor will produce a return energy to the inverter and cause the DC voltage of the inverter to increase. So when the function of over-voltage stall prevention is started, if the DC voltage of the inverter becomes too high, the inverter will stop decelerating till the voltage at DC decreases below the set value, then the inverter will go on to decelerate and the ramp-down time will be extended automatically.

PD119	Stall Prevention Level at Ramp-up	Set Range: 0—200%	Unit: 1%	Factory Setting: 150
-------	-----------------------------------	-------------------	----------	----------------------

When the inverter is in ramp-up, due to overload or too short ramp-up time, the output current of the inverter will go up quickly and exceed the set standard level. When this happens, the inverter will stop accelerating. When the current returns under its set value, the inverter will go on to accelerate.

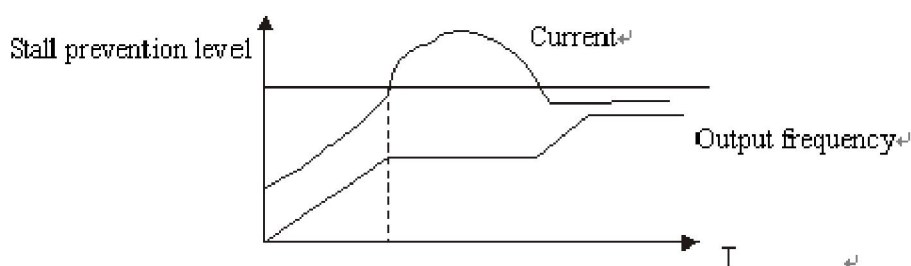

100% current is the rated current of the motor. When this parameter is set to 0, the stall prevention function is invalid.

PD120	Stall Prevention Level at Constant Speed	Set Range: 0—200%	Unit: 1%	Factory Setting: 0
-------	--	-------------------	----------	--------------------

When the inverter is running at constant speed, due to load fluctuation and other reasons, the current will increase. When the current exceeds its set standard value, the inverter will lower the output frequency. When the output current returns to its normal range, the inverter will accelerate again to its set frequency.

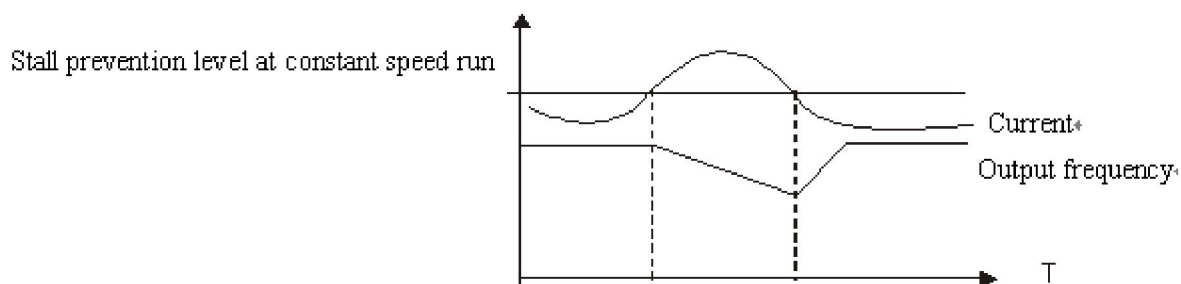

100% current is the Rated Current of the motor. When this parameter is set to 0 the stall prevention function is invalid.

PD121	Decel. Time for Stall Prevention at Constant Speed	Factory Setting: 5.0
-------	--	----------------------

When the inverter is used for the loads of kinds of fan and pump PD120 can be set to 120. When the current of the inverter is greater than 120% the output frequency will decrease and the current will also decrease accordingly. After the current returns to normal the frequency will return to normal slowly, so as to achieve the stall prevention function. The decreasing speed of the frequency is determined by PD121. For the Related parameters refer to CD 122.

PD122	Stall Prevention Level at Deceleration		
	Set Range: 0—200%	Unit: 1	Factory Setting: 150

Refer to PD118.

Stall prevention level at decelerating run

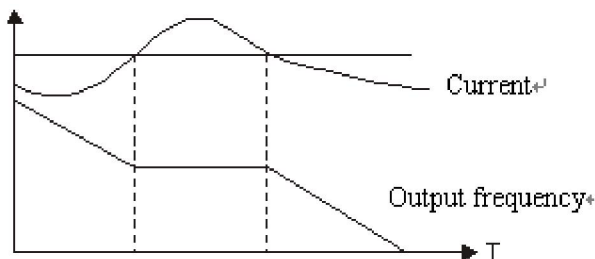

100% current is the rated current of the motor.

PD123	Over-torque Detect Mode		
	Set Range: 0—3	Unit: 1	Factory Setting: 0

0: When reaching the frequency it starts to detect over-torque and when over-torque is detected it continues to run.

1: When reaching the frequency it starts to detect over-torque and when over-torque is detected it stop running.

2: It detects over-torque during running and when over-torque is detected it continues to run.

3: It detects over-torque during running and when over-torque is detected it stop running.

PD124	Over-torque Detect Level		
	Set Range: 0—200%	Unit: 1%	Factory Setting: 0

When the output current exceeds the over-torque detection level and also exceeds half of the set time of over-torque detection (factory setting: 1.0s), the over-torque detection will indicate, and the corresponding multi-function alarm contact will act. When it exceeds the set time, the inverter will turn to self-protection. When this parameter is set to 0, the over-torque detection will be invalid

PD125	Over-torque Detect Time		
	Set Range: 0.1—20.0s	Unit: 0.1s	Factory Setting: 1.0

When the inverter detects that the output current has exceeded the motor current set value, the inverter begins to calculate the over-torque time. When the over-torque time has exceeded half of the set detect time, the corresponding multi-function output contact will act, and produce the over-torque alarm, while the inverter will keep running. When the over-torque time has exceeded

the set detect time (set by PD125), the inverter will turn to self-protection, display the fault information and stop output..

For the related parameters refer to PD124.

*PD130	Number of Auxiliary Pump			
	Set Range: 0—2	Unit: 1		Factory Setting: 0

*** This function is not available for the inverter of J series.**

This parameter is set for the number of auxiliary pump. The start or stop of the auxiliary pumps is controlled by using the multi-output contacts and Auxiliary Pump 1 or Auxiliary Pump 2 is controlled through the peripheral control circuit.

*PD131	Continuous Running Time of Auxiliary Pumps			
	Set Range: 1—9000 (min)	Unit: 1		Factory Setting: 60

*** This function is not available for the inverter of J series.**

In case of two pumps with only one pump in duty, in order to ensure each pump to work evenly, it will be switched to another pump when its running time reaches the set value of PD131.

*PD132	Interlocking Time of Auxiliary Pump			
	Set Range: 1—250S	Unit: 1		Factory Setting: 5S

*** This function is not available for the inverter of J series.**

This parameter is set to determine the interlocking time of two auxiliary pumps when switching with each other.

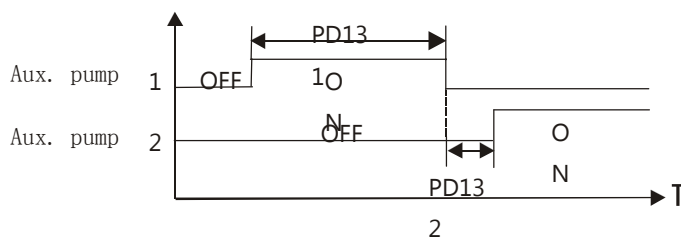

*PD133	High Speed Running Time			
	Set Range: 1—250S	Unit: 1		Factory Setting: 60S

*** This function is not available for the inverter of J series.**

In the application of water supply with constant pressure, when the master pump is running at the frequency of high speed (set by PD060) due to larger water volume and the high speed running time (PD133) is reached, the corresponding multi-function contacts act and the auxiliary pumps start.

*PD134	Low Speed Running Time			
	Set Range: 1—250S	Unit: 1		Factory Setting: 60S

*** This function is not available for the inverter of J series.**

In the application of water supply with constant pressure, when the master pump is running at the frequency of low speed (set by PD061) due to smaller water volume and the low speed running time (PD134) is reached, the corresponding multi-function contacts act and the auxiliary pumps

stop.

PD133 and PD134 must be used in combination of PD060, PD061 and multi-outputs. Their main function is to increase or decrease the number of auxiliary pump.

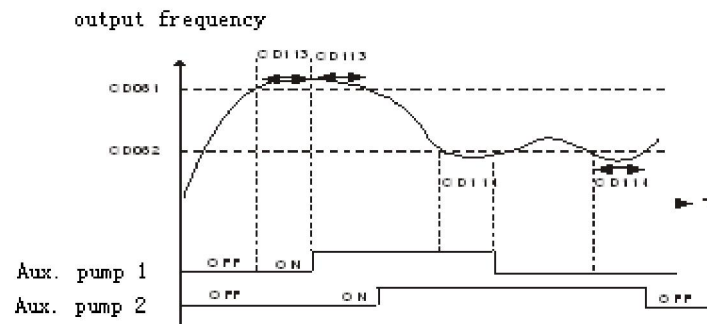

*PD135 Stopping Voltage Level

Set Range: 0—150%

Unit: 1

Factory Setting: 95%

*** This function is not available for the inverter of J series.**

This parameter is set for the voltage level of the master pump entering into sleep mode. For details refer to the following description.

*PD136 Lasting Time of Stopping Voltage Level

Set Range: 1—250S

Unit: 1

Factory Setting: 30S

*** This function is not available for the inverter of J series.**

This parameter is set for the lasting time under the stopping voltage level before entering into sleep mode. For details refer to the following description.

*PD137 Wakeup Voltage Level

Set Range: 1—150%

Unit: 1

Factory Setting: 80%

*** This function is not available for the inverter of J series.**

This parameter is set for the wakeup voltage level from sleep to wakeup.

*PD138 Sleep Frequency

Set Range: 0.00—400.0

Unit: 1

Factory Setting: 20.00

*** This function is not available for the inverter of J series.**

This parameter is set for the lowest operating frequency entering into sleep mode.

*PD139 Lasting Time of Sleep Frequency

Set Range: 1—250S

Unit: 1

Factory Setting: 20S

*** This function is not available for the inverter of J series.**

This parameter is set for the lasting time to run at sleep frequency when entering into sleep mode.

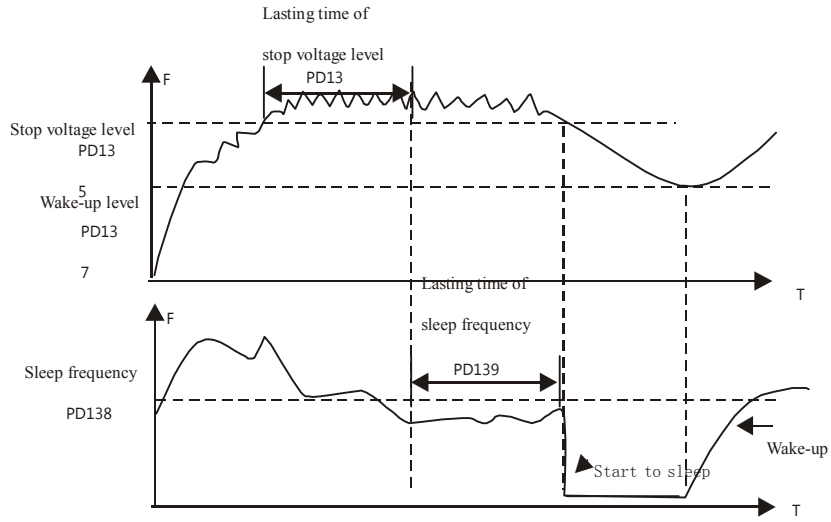

The following is the block diagram of multi pumps operation:

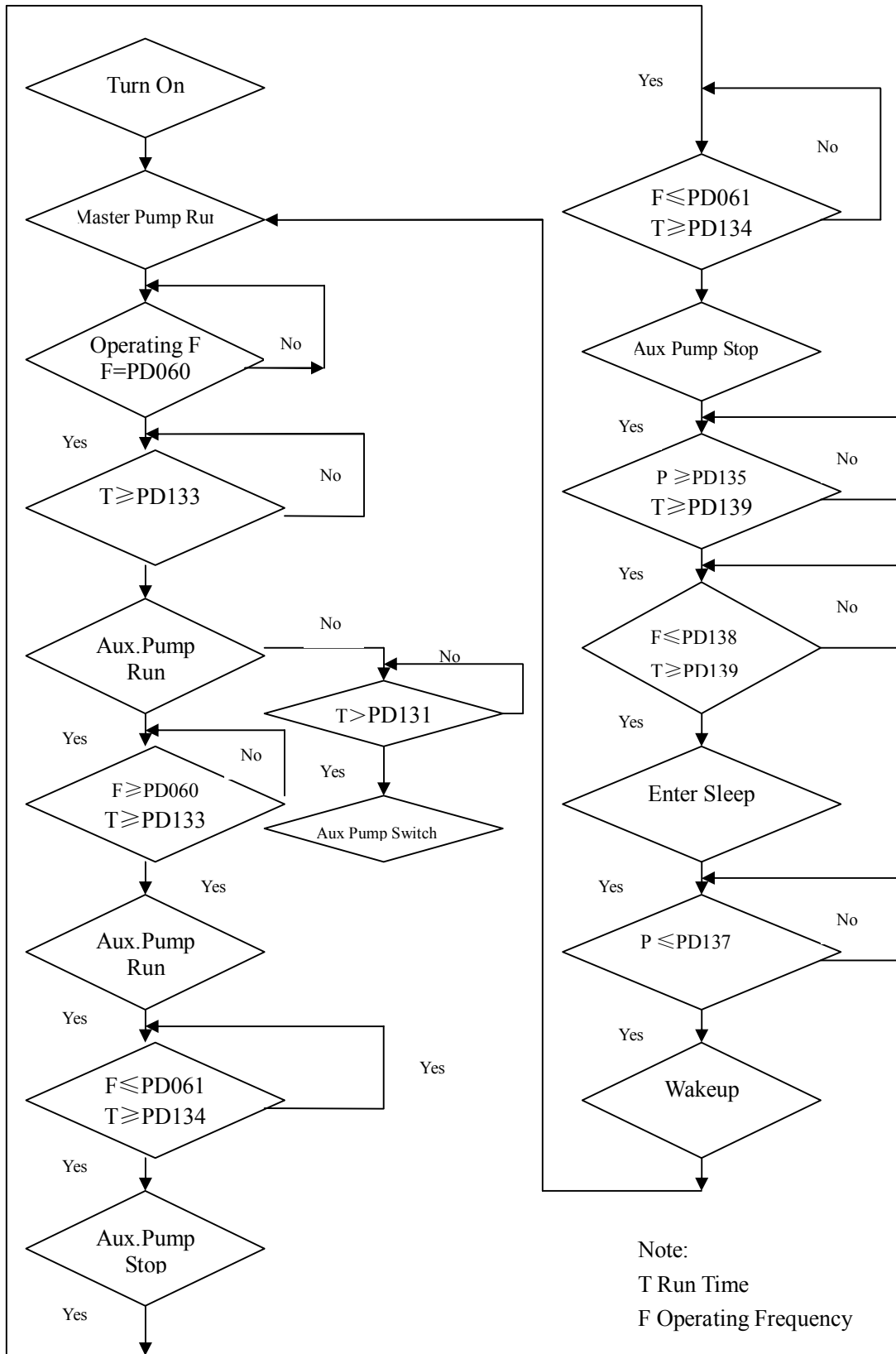

PD141	Rated Motor Voltage	Unit: 0.1V	Factory Setting: *
-------	---------------------	------------	--------------------

It is set according to the rated voltage value of the nameplate of the motor. For the inverters of 230V class the factory setting is 220, while for the inverters of 400 V class the factory setting is 380.

PD142	Rated Motor Current	Unit: 0.1A	Factory Setting: *
-------	---------------------	------------	--------------------

It is set according to the rated value of the nameplate of the motor. This parameter can be used to restrict the output current of the inverter to prevent over-current and protect the motor. If the current of the motor has exceeded this value the inverter of AC motor will turn to self-protection.

PD143	Motor Pole Number	Set Range: 02—10	Unit: 1	Factory Setting: 04
-------	-------------------	------------------	---------	---------------------

This parameter is set for the number of the motor's pole according to the nameplate of the motor.

PD144	Rated Motor Revolution	Set Range: 0—9999	Unit: 1r/min	Factory Setting: 1440
-------	------------------------	-------------------	--------------	-----------------------

This is set according to the actual revolution of the motor. The displayed value is the same as this set value. It can be used as a monitoring parameter, which is convenient to the user. This set value corresponds to the revolution at 50Hz.

PD145	Auto Torque Compensation	Set Range: 0.1—10.0 %	Unit: 0.1%	Factory Setting: 2.0%
-------	--------------------------	-----------------------	------------	-----------------------

This parameter can be set for the auto output of extra voltage when the inverter is running to achieve higher torque, which can compensate for the under-torque at lower frequency. The torque compensation should not be too big and it should be set slowly from low to high according to the actual situation.

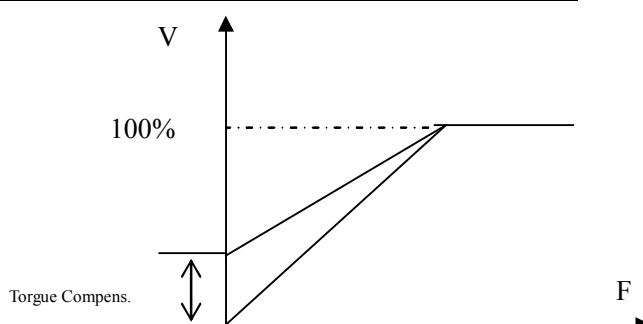

Insufficient compensation will result in the under-torque of the motor at lower frequency. And over compensation will lead to too bigger torque, which will produce a shock to the machine and even result in a trip of the inverter under serious situation.

PD146	Motor No-load Current	Set Range: 0—99	Unit: 1	Factory Setting: 40
-------	-----------------------	-----------------	---------	---------------------

The setting of motor no-load current will affect the value of slip compensation. The current is 100% of the rated current of the motor.

PD147	Motor Slip Compensation	Set Range: 0.0—10.0	Unit: 0.1	Factory Setting: 0.0
-------	-------------------------	---------------------	-----------	----------------------

When the inverter drives the motor the slip becomes bigger due to the increase of load. This parameter can be set for slip compensation to decrease the slip and make the running speed of the motor closer to the synchronous revolution.

PD150	Auto Voltage Regulation	Unit: 1	Factory Setting: 1
	Set Range: 0—1		

0: Invalid

1: Valid

When the input power is not stable and if the voltage is too high the operation of the motor with the power exceeding the rated voltage will cause increase of the temperature of the motor, damage of its insulation and unstable output torque. This auto voltage regulation can automatically stabilize the output voltage within the rated voltage range of the motor under the condition of unstable output power supply

When this function is set to invalid the output voltage will fluctuate.

PD151	Auto Energy Saving	Unit: 1%	Factory Setting: 0
	Set Range: 0—10%		

When it is set to zero this function is invalid. When Auto energy saving function is started the inverter will run at the full voltage during ramp-up or -down. During the operation at constant speed the inverter can automatically calculate the optimum voltage value according to the power of load and supply power to the load to achieve the goal of energy saving.

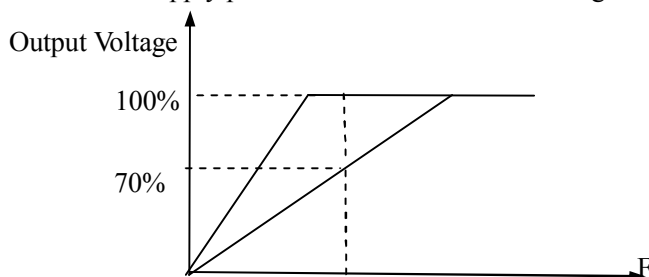

Auto energy saving can reduce the normal output voltage by max 30%. For the load with frequent changes or closing to full load, this function is not suitable.

PD152	Fault Restart Time	Factory Setting: 1.0 s
-------	--------------------	------------------------

When the inverter is set for fault restart and if it has a fault trip with the time exceeding the set value of PD152 the inverter will restart. When using this function pay more attention to the safety.

PD153	Restart after Instantaneous Stop	Unit: 1	Factory Setting: 0
	Set Range: 0—1		

0: Invalid, i.e. the inverter will not restart after an instantaneous power breakdown.

1: Start by frequency track. Refer to PD032.

PD154	Allowable Power-Breakdown Time
-------	--------------------------------

Set Range: 0.1—5.0S	Unit: 0.1S	Factory Setting: 0.5
---------------------	------------	----------------------

This parameter is set for the maximum allowable power failure time. If exceeding the set time the inverter will continue to stop output after power on. To restart the inverter it needs to follow the general starting procedures.

PD155	Number of Abnormal Restart		
	Set Range: 00—10	Unit: 1	Factory Setting: 00

After the abnormal conditions (such as over-current and over-voltage) happens the inverter will automatically reset and restart. If the starting mode is set to normal mode it will start according to the normal procedures. If it is set to start by frequency track it will start in the frequency track mode. After starting it will restore the set number again if there is no more abnormality happened within 60 seconds. If there is still any error and it reaches the set number the inverter will stop output. It can only be started after reset. When PD155 is set to zero the inverter will not carry out the functions of automatic reset and restart.

*PD156	Proportional Constant (P)		**
	Set Range: 0.0~1000.0%	Unit: 0.1%	Factory Setting: 100%

*** This function is not available for the inverter of J series.**

This proportional constant is set for the error value gain. In case of I=0, D=0, it is only for proportional control.

*PD157	Integral Time (I)		**
	Set Range: 0.1~3600.0s	Unit: 0.1s	Factory Setting: 5.0s

*** This function is not available for the inverter of J series.**

The integral time (I) is set for the responding speed for PID. The larger the I value is set the slower the responding speed will be. To the contrary, if the responding speed is quick but the integral time value is set too small, it will cause oscillation.

*PD158	Differential Time (D)		**
	Set Range: 0.01~10.00s	Unit: 0.01s	Factory Setting: 0

*** This function is not available for the inverter of J series.**

This differential time (D) is set for the depression operation of PID. The larger the D value is, the more obvious the depression operation will be. When D is set to zero, this function is invalid.

*PD159	Target Value		**
	Set Range: 0~100.0%	Unit: 1%	Factory Setting: *

*** This function is not available for the inverter of J series.**

This target value can be set through external voltage signal or the digital operator. 100% target value is corresponding to the analog frequency at +10V.

PID closed-loop control is usually used in the process control with physical quantity not changing fast, such as the controls of pressure and temperature, etc. The feedback signal is usually taken

from temperature transmitter, or pressure transmitter, etc. Under PID control, the feedback signal input path is the analog current signal of 4-20mA.

PID closed-loop control is valid when Multi-input PID is started.

PID Control Block Diagram:

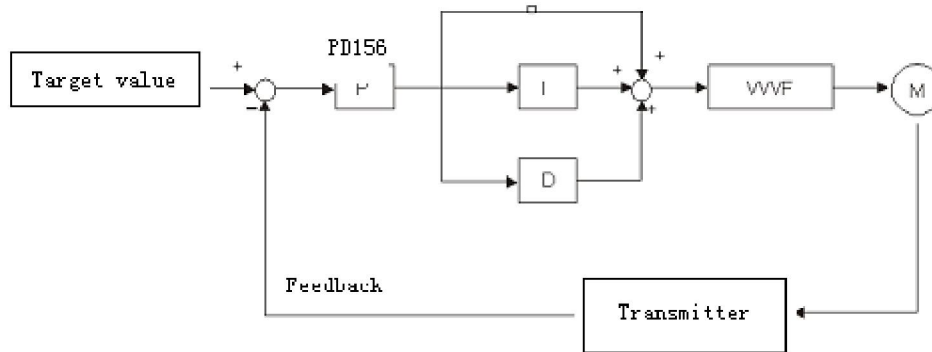

General operating methods of PID control:

- (1) Choose the correct transmitter (with the output specification of standard current signal 4-20mA).
- (2) Set the right target value.
- (3) If the output does not have oscillation, increase the proportional constant (P).
- (4) If the output does not have oscillation, decrease the integral time (Ti).
- (5) If the output do not have oscillation, increase the differential time (Td).
- (6) Concrete applications can be referred to the example application descriptions in Appendix 1.

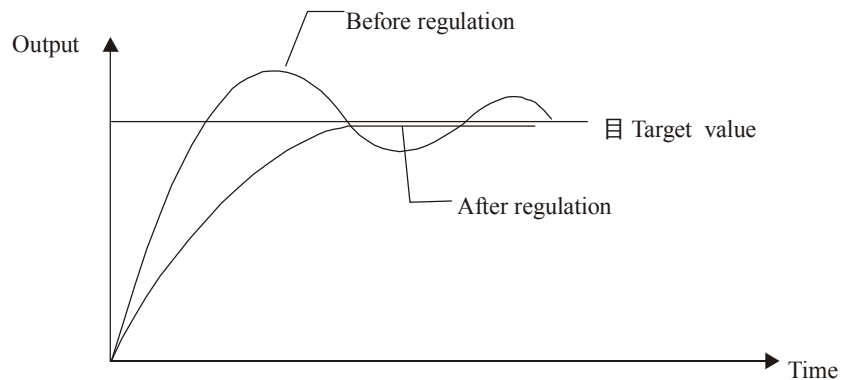

1. Suppress the Over Output

- a: Decrease the differential time (D value)
- b: Increase the integral time (I value)

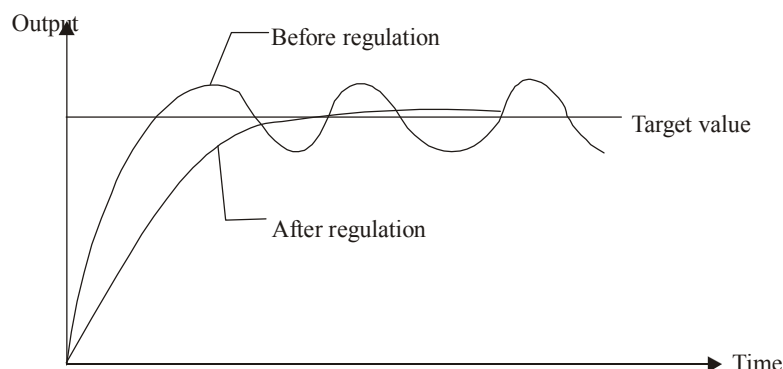

2. Suppress the oscillation
 - a: Decrease the differential time (D value) or set it to zero.
 - b: Decrease Proportional Constant (P value)

*PD160	PID Target Value		**
	Set Range: 0—1	Unit:	Factory Setting: 0

*** This function is not available for the inverter of J series.**

The target value can be set through the selection of the panel or external analog. The external analog is 0~10V signal or given by the potentiometer.

When PD160=0, the target value of PID is the value set by PD159.

When PD160=1, the target value of PID is the value of the external analog 0-10V (corresponding to 0-100%), the setting of PD159 is invalid.

*PD161	PID Upper Limit		**
	Set Range: 0—100%	Unit:	Factory Setting: 100%

*** This function is not available for the inverter of J series.**

When PID feedback value is more than the set value of PD161 the corresponding multi-output will act and the inverter will not stop.

*PD162	PID Lower Limit		**
	Set Range: 0—100%	Unit:	Factory Setting: 0%

*** This function is not available for the inverter of J series.**

When PID feedback value is less than the set value of PD162 the corresponding multi-output will act and the inverter will not stop.

PD163	Communication Addresses		
	Set Range: 00—250	Unit:	Factory Setting: 00

When the inverter is set for RS-485 Communication interface control, each of the inverters will be set for its individual identification number through PD163.

00: No communication function.

01~250: Address for the inverters

PD164	Communication Baud Rate		
	Set Range:	Unit:	Factory Setting: 1

0: 4800 b/s 1: 9600 b/s 2: 19200 b/s 3: 34800 b/s

PD165	Communication Data Method		
	Set Range:	Unit:	Factory Setting: 0
0:	8N1 For ASCII	1: 8E1 For ASCII	2: 8O1 For ASCII
3:	8N1 For RTU	4: 8E1 For RTU	5: 8O1 For RTU

MODBUS Communication Protocol

When using the RS485 communication interface, each of the inverters must be set for its own address so that the computer can use this individual address to carry out the control.

1: The communication protocol has two kinds of control mode:

- (1) RTU (Remote Terminal Unit) mode
- (2) ASCII (American Standard Code for information interchange) mode

Information of codes:

RTU mode: Each of 8-bit data is composed of two 4-bit (hexadecimal), for example: 64H

ASCII mode: Each of 8-bit data is composed of two ASCII byte, for example:

One 1-bit data 64H (hexadecimal) is composed of ASCII byte "64", included "6" (36H) and "4" (34H).

Byte	0	1	2	3	4	5	6	7
ASCII code	30H	31H	32H	33H	34H	35H	36H	37H

Byte	8	9	A	B	C	D	E	F
ASCII Code	38H	39H	41H	42H	43H	44H	45H	46H

2: Communication Data Method

- (1) 8N1 For ASCII PD165=0

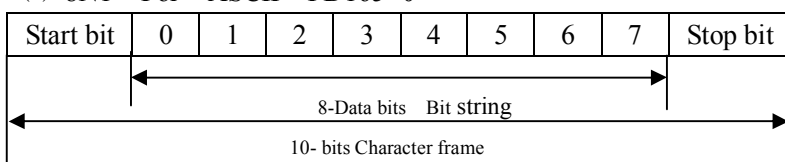

- (2) 8E1 For ASCII PD165=1

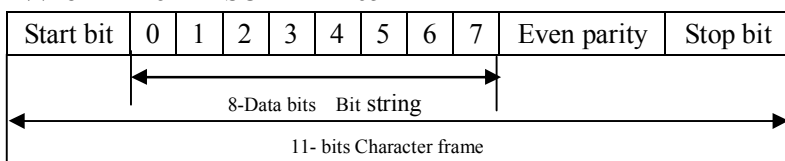

- (3) 8O1 For ASCII PD165=2

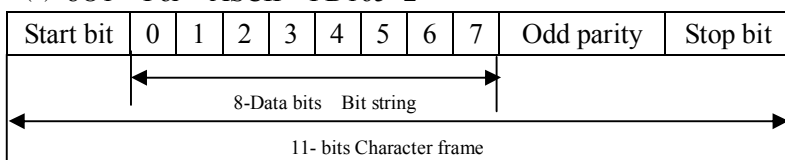

(4) 8N1 For RTU PD165=3

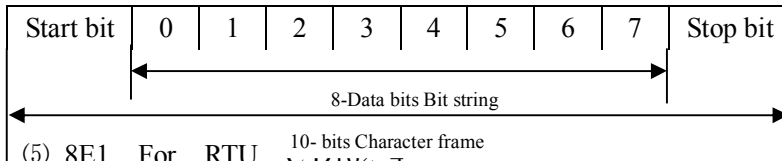

(5) 8E1 For RTU 10- bits Character frame

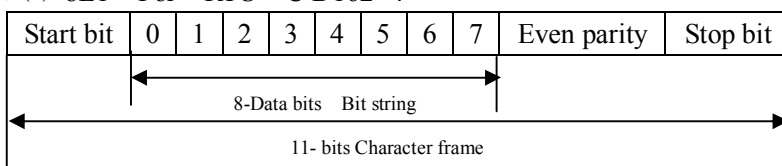

(6) 8O1 For RTU PD165=5

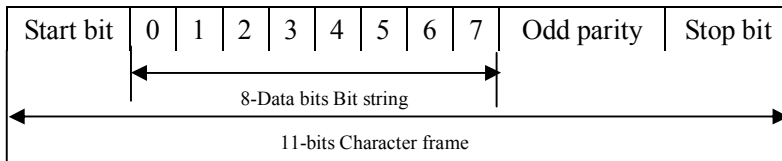

3: Communication Document Formats

3.1 ASCII Mode

Communication Document Forms

STX “:” (3AH)	ADDR	FUNC	LEN	DATA (n-1) ... DATA ₀	CRC	END CR (0DH) LF (0AH)
-------------------------	------	------	-----	---	-----	-----------------------------

(1) STX: Starting unit “:” (3AH)

(2) ADDR communication address, 8-bit data is composed of two ASCII byte.

00: Broadcast mode is MODBUS

01~250: Address of the corresponding inverters.

(3) FUNC: Function code 8-bit data is composed of two ASCII byte.

01: FUNC READ, Read the data of function code

02: FUNC WRIT, write the data of function code

03: Write control data

04: Read control status data

05: Write inverter frequency data

06: Reserved

07: Reserved

08: Loop test

a: Read function code data

Format:

ADDR 01 LEN FUNC Data

ADDR=0 means no answer

ADDR≠0 means a reply from inverter of this address

When inverter reply normal, the format as follows:

ADDR 01 LEN FUNC Data

If DATA is one word, the LEN=3, If DATA is one byte, the LEN=2 .

When inverter has no this function code or reply no effect, the format as follows:

ADDR 81H 01 FUNC

b: Write function code data

Format:

ADDR 02 LEN FUNC Data

ADDR=0 for broadcast, it write to all inverter, but no reply.

ADDR≠0, set data and reply from inverter of this address.

When the setting is incorrect or the inverter does not have this function, the format returned is as follows:

ADDR 81H 01 FUNC

c: Control commands

Format:

ADDR 03 LEN CNTR

ADDR=0 for broadcast, it write to all inverter, but no reply

ADDR≠0, reply and return.

CNTR

7	6	5	4	3	2	1	0
jogr	jogf	jog	r/f	stop	rev	for	run

When the setting is correct it will return to present control status.

Format: ADDR 03 LEN CNST

CNST

7	6	5	4	3	2	1	0
Track start	Braking	r/f	jogging	running	r/f	jog	run

When the check is not correct,

ADDR 83H 01 CNST

d: Read status value

Format:

ADDR 04 01 CFG

ADDR=0, no reply

ADDR≠0, reply.

CFG=0~7, reply single data

0: Set F 1: Out F 2: Out A 3: RoTT

4: DCV 5: ACV 6: Cont 7: Tmp

For example: read agreed frequency

Send: 01 04 03 00 CRC

Return: 01 04 03 13 88 CRC

In which, 13 88 are data

13 for high order, while 88 for low order.

(4) LEN: data length, It means the length of $D_{(n-1)} \cdots D_0$, Length set: when one word, LEN=3, when one byte or <1byte, LEN=2.

(5) DATA: <Data characters> data content. 2n ASCII compose n bytes, it have fifty ASCII at most.

(6) LRC: longitudinal redundancy check

ASCII mode: Get LRC methods is that add ADDR to the last data, if the result is more than 256, then the result subtract 256 until the result is less than 256 (if the result is 128H, take 28H), then 100H subtract the result get LRC.

(7) For example: write 30.00Hz to inverter of 01 (write to PD003)

STX	ADDR	FUNC	LEN	DATA	LRC	END
“.”	“0” “1”	“0” “2”	“0” “3”	“0” “0” “0” “B” “B” “8”	“3” “7”	“CR” “LF”
3AH	30H 31H	30H 32H	30H 33H	30H 30H 30H 42H 42H 38H	33H 37H	0DH 0AH

Calculate LRC: 01H+02H+03H+00H+0BH+B8H=C9H

C9H subtracted from 100H: 37H

So the sent data is following: 3AH 30H 31H 30H 32H 30H 33H 30H 30H 30H
 42H 42H 38H 33H 37H 0DH 0AH

3.2 RTU Mode

Quiet	ADDR	FUNC	LEN	D _(n-1) ~ D ₍₀₎	CRC	Quiet
>50ms						>50ms

- (1) Quiet: the time of no data is more than 50 ms
- (2) ADDR: Communication address, 8-bit data
- (3) FUNC: Function code, 8-bit data, refer to 3.1-3
- (4) LEN: Data length, the length of D_(n-1) ~ D₀
- (5) DATA: data content, n*8-bit
- (6) LRC: Longitudinal Redundancy Check

RTU mode: get CRC (cyclical Redundancy Check) .

The CRC calculation method is following:

- (1) make a 16-bit register and set value 0FFFFH(call CRC register)
- (2) done first byte of data Exclusive OR with low byte of 16-bit CRC register and save the result to CRC register
- (3) done 1 bit right shift with CRC register and fill zero to left bit, then check low bit of CRC register.
- (4) if the low bit is zero, then do repeat step3, else CRC register do Exclusive OR with 0A001H.
- (5) done repeat step 3 and 4, until CRC register done right shift 8 times, then the byte is fully done.
- (6) done repeat step 2 to 5 for the next byte of data, until process completely all data. The last data of CRC register is CRC value. When send CRC value in command data, low bytes must change the sequence with high bytes, i.e. low bytes will be sent first.
- (7) Example 1: Write 30.00Hz to inverter of 01

Command data

ADDR	FUNC	LEN	DATA	CRC
01H	02H	03H	00H 0BH B8H	7FH 0CH

Sent data: 01H 02H 03H 00H 0BH B8H 7FH 0CH

(8) Example 2:

The following is that get CRC value with C language. The function has two parameters:

```

Unsigned char data ←—— the point of data buffer
Unsigned char length ←—— number of data buffer
This function will send back the CRC value with unsigned integer format.
Unsigned int crc_chk (unsigned char data, unsigned char length)
{
int j;
unsigned int reg_crc=0xffff;
while (length--){
reg_crc^=*data=++;
for(j=0;j<8;j+=){
if(reg_crc&0×01){/*LSB(b0)=1*/
reg_crc=(reg_crc>>1)^0xa001;
}else{
reg_crc=reg_crc>>1;
}
}
}
return reg_crc;
}

```

PD170	Display Items			
	Set Range:	0—5	Unit: 1	Factory Setting: 0

This parameter is only valid when Bit 2 is set to 1 in PD171. For the details refer to PD171.

- 0: Inverter Temperature
- 1: Counter Value
- 2: PID Target Value
- 3: PID Feedback Value
- 4: Present running time of power up (Unit: Hour)
- 5: Total running time of power up (Unit: Hour)

PD171	Display Items Open			
	Set Range:	0—7	Unit: 1	Factory Setting: 0

This parameter is set for selection of displaying of DC voltage, AC voltage and other items so that the customer can monitor and view them in sequence through the switch key.

It can be is set first in the binary 3 bits mode, and then converted to a decimal value.

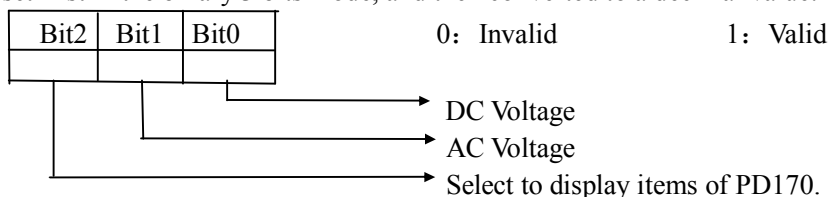

In the contents displayed the factory setting is to show output frequency, set frequency, output current and output revolution through the switch key. If it is necessary to view and monitor other items they can be set through PD170 and PD171.

PD172	Fault Clear	**
	Set Range: 00—10	Unit: 1 Factory Setting: 00

01 is for fault clear. Others have no function.

PD174	Rated Current of Inverter	Unit: 1A	Factory Setting: *
-------	---------------------------	----------	--------------------

It is depending on the model and can't be changed.

PD175	Inverter Model	
	Set Range: 0—1	Unit: 1 Factory Setting: 0

0: Constant torque 1: For kinds of fan. It can be observed, but not changed.

PD176	Inverter Frequency Standard	Unit: 1	Factory Setting: *
-------	-----------------------------	---------	--------------------

0: 50Hz 1: 60Hz It is factory setting. It can be observed, but not set.

PD177	Fault Record 1	Factory Setting: _____
PD178	Fault Record 2	Factory Setting: _____
PD179	Fault Record 3	Factory Setting: _____
PD180	Fault Record 4	Factory Setting: _____

When it has no fault record it shows _____. After access to this parameter the fault display can be checked.

PD181	Software Version	Factory Setting: *
-------	------------------	--------------------

It can be observed, but not set.

PD182	Manufacture date	Factory Setting: *
-------	------------------	--------------------

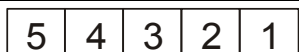

It is factory setting. It can be observed, but not set.

Week
Month
Year

PD183	Serial No.	Factory Setting: *
-------	------------	--------------------

It is factory setting. It can be observed, but not set.

Note:

* means the said parameter has a variety of set values or should be set specifically according to concrete conditions.

** means the said parameter can be set during the operation.

